

Installation & Operation Manual

KBVF SERIES

Chassis / IP-20 AC Drives

Variable Speed / Soft-Start
with Electronic Motor Overload Protection*

Rated for 208-230 Volt 50 & 60 Hz
3-Phase & PSC** AC Induction Motors
from Subfractional thru 1½ HP

Operates from 115 and 208/230 Volt
50/60 Hz AC Line Input***



See Safety Warning,
on pages 8 and 9.

This manual covers Models
KBVF-21D, 22D, 13, 23, 23D, 14, 24, 24D, 26D

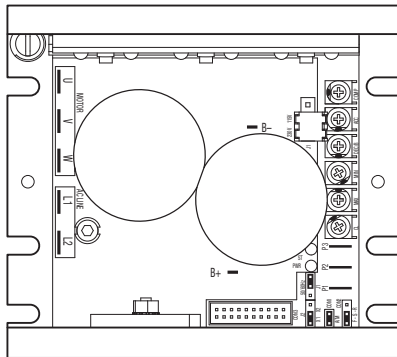

Note: The drive is factory set for
60 Hz motors. For 50 Hz motors,
see Section 6.2, on page 25.



The information contained in this manual is intended to be accurate. However, the manufacturer retains the right to make changes in design which may not be included herein.

UL approved as an electronic overload protector for motors. **Custom software is required for PSC motors. See PSC Motor Addendum (Part No. A42142). *Do not use this drive with GFCIs. Special software is required — Contact our Sales Department. ****Requires CE approved RFI Filter. See RFI Filters & Chokes Selection Guide D-321 (Part No. A42027) for selection of filters to meet the Industrial or Residential Standard.*

PENTA KB POWER™

A Complete Line of Motor Drives

© 2006 KB Electronics, Inc.
(see back cover)

TABLE OF CONTENTS

Section	Page
1 Quick-Start Instructions.	6 – 8
2 Safety Warning	8 – 9
3 Introduction.	9 – 20
4 Important Application Information	20 – 22
5 Finger-Safe Cover	22 – 23
6 Setting Selectable Jumpers.	23 – 27
7 Mounting Instructions	27 – 28
8 Recommended High Voltage Dielectric Withstand Testing (Hi-Pot Testing)	28 – 30
9 Wiring Instructions.	30 – 35
10 AC Line Fusing	35
11 Drive Operation	36 – 37
12 Diagnostic LEDs	37 – 38
13 Trimpot Adjustments	38 – 43
Limited Warranty	44

Table	Page
1 Electrical Ratings.	14
2 General Performance Specifications	15
3 Fault Recovery and Resetting the Drive.	36
4 Drive Operating Condition and Status LED Indicator.	38

Figure	Page
1 Quick-Start Connection Diagram.	5
2A Models KBVF-21D, 22D, 13, 23, 23D Mechanical Specifications and Control Layout.	16
2B Models KBVF-21D, 22D, 13, 23, 23D Mechanical Specifications	17

TABLE OF CONTENTS (Continued)

Figure		Page
3A	Models KBVF-14, 24, 24D, 26D Mechanical Specifications	18
3B	Models KBVF-14, 24, 24D, 26D Mechanical Specifications	19
4	Expanded View of Jumpers and Trimpots.	20
5	Maximum Allowed Motor Torque vs. Speed	21
6	Open Ventilated Motor with External Cooling	21
7	Models KBVF-21D, 22D, 23D, 24D AC Line Input Voltage Selection	24
8	Model KBVF-26D AC Line Input Voltage Selection	24
9	Removing Jumper J1 on Model KBVF-26D	25
10	60 Hz and 50 Hz Motor Selection.	25
11	Available Torque vs. Output Frequency	26
12	120 Hz and 100 Hz Drive Output Frequency Selection	26
13	Automatic Start	27
14	Forward/Reverse Speed Selection	27
15	Typical Hi-Pot Setup	29
16	AC Line Input, Motor, and Ground Connections	31
17	Main Speed Potentiometer Connection.	32
18	Voltage Following Connection	33
19	Manual Start Switch Connection	34
20	Forward-Stop-Reverse Switch Connection	34
21	Enable Switch connection.	35
22	Minimum Speed Trimpot (MIN) Range.	39
23	Maximum Speed Trimpot (MAX) Range.	39
24	Acceleration Trimpot (ACC) Range	39
25	Deceleration Trimpot (DEC/B) Range.	40
26	Slip Compensation Trimpot (COMP) Range.	40

TABLE OF CONTENTS (Continued)

Figure		Page
27	Boost Trimpot (DEC/B) Range	40
28	Model KBVF-21D Current Limit Trimpot (CL) Range	43
29	Model KBVF-22D Current Limit Trimpot (CL) Range	43
30	Models KBVF-13, 23, 23D Current Limit Trimpot (CL) Range	43
31	Models KBVF-14, 24, 24D Current Limit Trimpot (CL) Range	43
32	Model KBVF-26D Current Limit Trimpot (CL) Range	43

Items Included in this Package:

KBVF Adjustable Frequency Drive, KBVF Series Installation and Operation Manual, Main Speed Potentiometer Kit with Insulator and Mounting Hardware, Main Speed Potentiometer Terminals (3 Orange), Motor and AC Line Terminals (5 Blue), 2-Wire and 3-Wire Connector Kit, Status Indicator Label, Trimpot Adjustment Tool, CE Approved Product Information Card, Warranty Registration Card.

FIGURE 1 – QUICK-START CONNECTION DIAGRAM

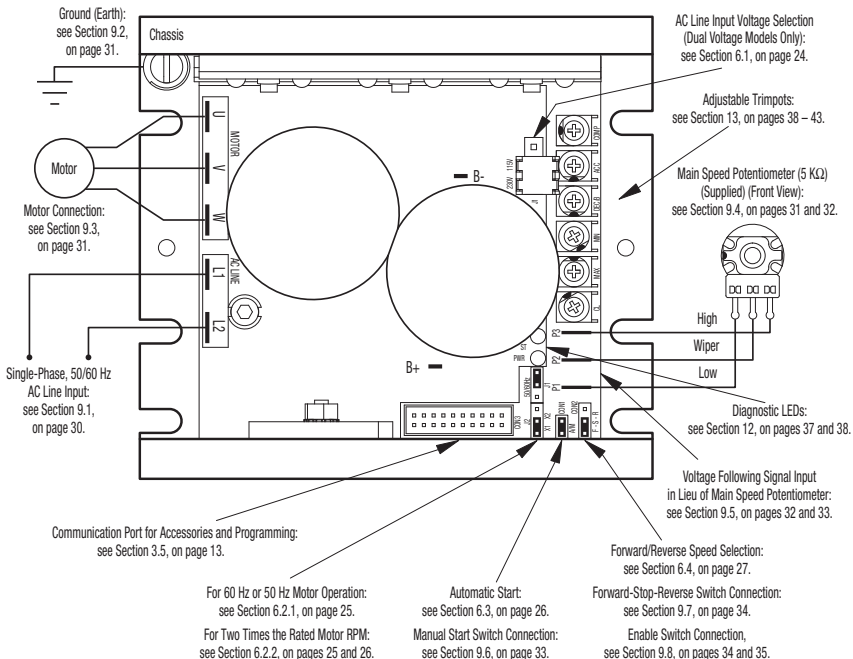

1 QUICK-START INSTRUCTIONS

Important – You must read these simplified instructions before proceeding. These instructions are to be used as a reference only and are not intended to replace the details provided herein. You must read the Safety Warning on, pages 8 and 9, before proceeding.

See Figure 1 on page 5. Also see Section 4 – Important Application Information, on pages 20 – 22.



WARNING! Disconnect main power when making connections to the drive.

- 1.1 AC Line Connection** – Wire the single-phase AC line input to Terminals “L1” and “L2”, as shown in Figure 16, on page 31. See Section 9.1, on pages 30 and 31.

Application Note: Do not wire this drive to a GFCI. If operation with a GFCI is required, contact our Sales Department.

Models KBVF-13, 14 – Rated for 115 Volt AC line input only.

Models KBVF-23, 24 – Rated for 208/230 Volt AC line input only.

Models KBVF-21D, 22D, 23D, 24D, 26D* – Rated for 208/230 Volt AC line input with Jumper J1 (on upper PC board) set to the “230V” position (factory setting). Rated for 115 Volt AC line input with Jumper J1 (on upper PC board) set to the “115V” position).

**On Model KBVF-26D, Jumper J1 is labeled “115VAC” and “230VAC”.*

- 1.2 Ground Connection** – Connect the ground wire (earth) to the ground screw, as shown in Figure 16, on page 31. See Section 9.2, on page 31.

Note: Model KBVF-21D, due to its double insulated design, does not contain a ground screw.

- 1.3 AC Line Fusing** – It is recommended that a fuse(s) or circuit breaker be installed in the AC line. Fuse each conductor that is not at ground potential. For the recommended fuse size, see Table 1, on page 14. Also see Section 10, on page 35.
- 1.4 Motor Connection** – Wire the motor to quick-connect Terminals “U”, “V”, “W”, as shown in Figure 16, on page 31. (Special reactors may be required for cable lengths over 100 ft. (30 m) – consult our Sales Department.) See Section 9.3, on page 31.

***Note:** The drive is programmed to operate 3-phase AC induction motors. For PSC motors, optional software is required – contact our Sales Department.*

- 1.5 60 Hz and 50 Hz Motor Operation (Jumpers J1 and J2 On the Lower PC Board)** – The drive is factory set for 60 Hz motor operation (Jumper J1 set to the “60Hz” position and Jumper J2 set to the “X1” position). For 50 Hz motor operation, set Jumper J1 to the “50Hz” position and be sure Jumper J2 is set to the “X1” position. See Section 6.2.1, on page 26.
- 1.6 Trimpot Settings** – All trimpots have been factory set for most applications, as shown in Figure 4, on page 20. Some applications require adjustment of the trimpots in order to tailor the drive for a specific requirement. See Section 13, on pages 38 – 43.
- 1.7 Main Speed Potentiometer Connection** – For unidirectional speed operation, wire the 5 k Ω potentiometer (supplied) to Terminals “P1” (low), “P2” (wiper), “P3” (high). See Section 9.4, on pages 31 and 32.
- 1.8 Voltage Following** – An *isolated** 0 – 5 Volt DC analog signal input can be used to control motor speed in lieu of the Main Speed Potentiometer. The drive output will linearly follow the analog signal input. Connect the signal input positive lead (+) to Terminal “P2” and the negative lead (-) to Terminal “P1”. See Section 9.5, on pages 32 and 33.

**If a non-isolated signal is used, install the SIVFR — Signal Isolator (Part No. 9597). The SIVFR accepts voltage (0 to ± 2.5 thru 0 to ± 25 Volts DC) or current (4 – 20 mA DC) signal inputs. See Section 3.5, on page 13.*

Note: For signal following operation, the Minimum Speed Trimpot (MIN) must be set fully counterclockwise.



WARNING! The signal input must be isolated from the AC line. Earth grounding signal wiring will damage the drive and void the warranty. It is recommended that the SIVFR — Signal Isolator and Run/Fault Relay (Part No. 9597) be installed when using signal following.

2 SAFETY WARNING

Definition of Safety Warning Symbols



Electrical Hazard Warning Symbol – Failure to observe this warning could result in electrical shock or electrocution.



Operational Hazard Warning Symbol – Failure to observe this warning could result in serious injury or death.



This product should be installed and serviced by a qualified technician, electrician, or electrical maintenance person familiar with its operation and the hazards involved.

Proper installation, which includes installation of the Finger-Safe Cover, wiring, mounting in proper enclosure, fusing or other current protection, and grounding can reduce the chance of electrical shocks, fires, or explosion in this product or products used with this product, such as electric motors, switches, coils, solenoids, and/or relays. Eye protection must be worn and insulated adjustment tools must be used when working with drive under power. This product is constructed of materials (plastics, metals, carbon, silicon, etc.) which may be a potential hazard. Proper shielding, grounding, and filtering of this product can reduce the emission of radio frequency interference (RFI) which may adversely affect sensitive electronic equipment. It is the responsibility of the equipment manufacturer and individual installer to supply this Safety Warning to the ultimate end user of this product. (SW/FSC 5/2005) Be sure to follow all instructions carefully. Fire and/or electrocution can result due to improper use of this product.

CE This product complies with all CE directives pertinent at the time of manufacture. Contact our Sales Department for Declaration of Conformity. Installation of a CE approved RFI filter is required. See RFI Filters & Chokes Selection Guide D-321 (Part No. A42027) for selection of filters to meet the Industrial or Residential Standard. Additional shielded cable and/or AC line cables may be required along with a signal isolator (SIVFR (Part No. 9597)).

3 INTRODUCTION

Thank you for purchasing the KBVF Adjustable Frequency Drive. KB Electronics, Inc. is committed to providing total customer satisfaction by producing quality products that are easy to install and operate. The KBVF is manufactured with surface mount components incorporating advanced circuitry and technology. A Finger-Safe Cover is included for added liability protection.

The KBVF Adjustable Frequency Drives provide variable speed control for standard 3-phase and Permanent Split Capacitor (PSC)¹ AC induction motors from subfractional thru 1½ HP. This manual covers models with single-phase AC line input only. The sine wave coded Pulse Width Modulated (PWM) output operates at a carrier frequency of 16 kHz, which provides high motor efficiency and low noise. Adjustable linear acceleration and deceleration are provided, making the drive suitable for soft-start applications.

Due to its user-friendly design, the KBVF AC drive is easy to install and operate. Tailoring to specific applications is accomplished with selectable jumpers and trimpots, which eliminate the computer-like programming required on other drives. However, for most applications no adjustments are necessary. For more advanced programming, PC based Drive-Link™ software is available.

Main features include adjustable RMS Current Limit and I²t Motor Overload Protection.² In addition, Adjustable Slip Compensation with Static Auto-Tune and Boost provides high torque and excellent load regulation over a wide speed range. Power Start™ delivers over 200% motor torque to ensure startup of high frictional loads. Electronic Inrush Current Limit (EICL™) eliminates harmful AC line inrush current.³ The drive is suitable for machine or variable torque (HVAC) applications. With optional Drive-Link™ software, the drive can be programmed for DC Injection Braking.

For AC line and motor wiring, quick-connect terminals are provided. Other features include: adjustable trimpots (MIN, MAX, ACC, DEC/B⁴, COMP CL), customer selectable jumpers (Automatic-Manual Start, Motor Frequency, Frequency Multiplier, Forward/Reverse, and Line Voltage (dual voltage models only)). Diagnostic LEDs are provided for power (PWR) and drive status (ST). A 5 kΩ Main Speed Potentiometer is also included.

A Signal Isolator is optional on all models, which can be used for single-ended or bidirectional speed control and accepts voltage or current signal input. Other optional accessories include: Class “A” and “B” AC Line Filters, Dynamic Brake Module, Multi-Speed Board, Programming Kit, and Modbus Communication Module. A connector is provided for easy installation of accessories.

Notes: **1.** *Optional software is required for PSC motors — contact our Sales Department.* **2.** *UL approved as an electronic overload protector for motors.* **3.** *Models KBVF-21D, 22D contain ICL in lieu of EICL™.* **4.** *In 50 Hz Mode, the DEC/B Trimpot automatically becomes Adjustable Boost.*

3.1 Standard Features

- **Simple to Operate** – Does not require programming. Uses trimpots and jumpers, which are factory set for most applications.
- **Diagnostic LEDs** – Power on (PWR) and drive status (ST). See Sec. 12, on pgs. 37 & 38.
- **Jumper Selection of Drive Output Frequency** – Increases the motor speed up to two times the rated RPM. See Section 6.2, on pages 25 and 26.
- **Industry Standard Mounting.** See Section 7, on pages 27 and 28.
- **Finger-Safe Cover** – Meets IP-20 standard. See Section 5, on pages 22 and 23.

Note: *GFCI Operation – This control can operate with GFCIs (optional software required).*

3.2 Performance Features

- **Power Start™** – Provides more than 200% starting torque which ensures startup of high frictional loads.
- **Slip Compensation with Static Auto-Tune and Boost** – Provides excellent load regulation over a wide speed range.
- **Speed Range** – 60:1

3.3 Protection Features

- **Motor Overload (I²t) with RMS Current Limit** – Provides motor overload protection which prevents motor burnout and eliminates nuisance trips. UL approved as an electronic overload protector for motors. See Section 4.2, on pg. 22, and Section 13.7, on pgs. 42 & 43.
- **Electronic Inrush Current Limit (EICL™)** – Eliminates harmful inrush AC line current during startup. Models KBVF-21D, 22D contain ICL in lieu of EICL™.

- **Short Circuit** – Prevents drive failure if a short circuit occurs at the motor (phase-to-phase).
- **Motor Filter** – Reduces harmful voltage spikes to the motor.
- **Regeneration** – Eliminates nuisance tripping due to bus overvoltage caused by rapid deceleration of high inertial loads.
- **Undervoltage and Overvoltage** – Shuts down the drive if the AC line input voltage goes above or below the operating range.
- **MOV Input Transient Suppression.**
- **Microcontroller Self Monitoring and Auto-Reboot.**

3.4 Trimpot Adjustments

- **Minimum Speed (MIN)** – Sets the minimum speed of the motor. See Sec. 13.1, on pg. 39.
- **Maximum Speed (MAX)** – Sets the maximum speed of the motor. See Sec. 13.2, on pg. 39.
- **Acceleration (ACC)** – Sets the amount of time for the motor to accelerate from zero speed to full speed. See Section 13.3, on page 39.
- **Deceleration (DEC/B)** – Sets the amount of time for the motor to decelerate from full speed to zero speed. See Section 13.4, on pages 39 and 40.
- **Slip Compensation (COMP)** – Maintains set motor speed under varying loads. See Section 13.5, on pages 40 and 41.
- **Boost (DEC/B)** – In 50 Hz mode, the trimpot automatically becomes Adjustable Boost, which can be used to set the Volts/Hz Curve for 50 Hz motors to obtain maximum performance. In 50 Hz Mode, the deceleration time is automatically set to the same as the acceleration time. See Section 13.6, on pages 41 and 42.
- **Current Limit (CL)** – Sets the current limit (overload) which limits the maximum current (torque) to the motor. See Section 13.7, on pages 42 and 43.

3.5 Optional Accessories

- **SIVFR — Signal Isolator and Run/Fault Relay (Part No. 9597)** – Provides isolation between a non-isolated signal voltage (0 to ± 2.5 thru 0 to ± 25 Volts DC) or current source (4 – 20 mA DC) and the drive. Can be used in single-ended or bidirectional mode. Run/Fault Relay Output Contacts are also provided, which can be used to turn on or off equipment or to signal a warning if the drive is put into the Stop Mode or a fault has occurred. Mounts on the end of the drive.
- **DBVF — Dynamic Brake Module (Part No. 9598)** – Provides up to 25% continuous braking and 200% instantaneous braking torque (maximum 1 HP (.75 kW)).
- **Multi-Speed Board (Part No. 9503)** – Provides multi-speed operation using external contacts or a PLC. Mounts on the end of the drive.
- **Programming Kit (Part No. 9582)** – Includes DownLoad Module™ (DLM) handheld programming device which uploads and downloads drive programs, PC to DLM serial communication cable, DLM to inverter communication cable, and PC Windows® based Drive-Link™ communication software.
- **DIVF — Modbus Communication Module (Part No. 9568)** – Allows the drive to communicate with PLCs, PCs, and HMIs with Modbus RTU protocol utilizing a serial communication cable. If a USB communication cable is required, purchase Part No. 19008.
- **RFI Filters and Chokes** – Provide RFI and EMI Suppression. They comply with CE Council Directive 89/336/EEC relating to the Class A Industrial and Class B Residential Standards. See RFI Filters and Chokes Selection Guide Publication No. D-321 (Part No. A42027).
- **Custom Software** – All models can be factory programmed for applications that require special switching, timing, PLC functions, and GFCI operation — contact our Sales Department.

TABLE 1 – ELECTRICAL RATINGS

Model	Part No.	AC Line Input			Drive Output			Fuse or Circuit Breaker Rating (Amps)	Net Wt.	
		Volts AC (50/60 Hz)	Phase (ϕ)	Maximum Current (Amps AC)	Voltage Range (Nominal) (Volts AC)	Maximum Continuous Load Current (RMS Amps/Phase)	Maximum Horsepower (HP (kW))		lbs	kg
KBVF-21D	9581	115	1	4.0	0 – 230	1.0	1/10 (.07)	5	0.7	0.3
		208/230	1	2.5						
KBVF-22D	9572	115	1	6.0	0 – 230	1.5	1/4 (.18)	10	1.3	0.6
		208/230	1	3.8				5		
KBVF-13	9957	115	1	11.0	0 – 230	2.4	1/2 (.37)	15	1.3	0.6
KBVF-23	9958	208/230	1	7.0	0 – 230	2.4	1/2 (.37)	10	1.3	0.6
KBVF-23D	9959	115	1	11.0	0 – 230	2.4	1/2 (.37)	15	1.3	0.6
		208/230	1	7.0				10		
KBVF-14	9977	115	1	16.0	0 – 230	4.0	1 (.75)	20	2.2	1.0
KBVF-24	9978	208/230	1	10.0	0 – 230	4.0	1 (.75)	15	2.2	1.0
KBVF-24D	9979	115	1	16.0	0 – 230	4.0	1 (.75)	20	2.2	1.0
		208/230	1	10.0				15		
KBVF-26D*	9496	115	1	22.0	0 – 230	5.5	11/2 (1.13)	25	2.9	1.3
		208/230	1	14.0				15		

*Model KBVF-26D is rated 2 HP (1.5 kW) for most Premium Efficient motors.

Note: All models contain Motor Filter and Quick-Connect Terminals for AC line and motor wiring. The Signal Isolator and Run/Fault Relay is optional on all models.

TABLE 2 – GENERAL PERFORMANCE SPECIFICATIONS

Description	Specification	Factory Setting
115 Volt AC Line Input Voltage Operating Range (Volts AC)	115 (±15%)	—
208/230 Volt AC Line Input Voltage Operating Range (Volts AC)	208 (-15%) / 230 (+15%)	—
Maximum Load (% Current Overload for 2 Minutes)	150	—
Carrier, Switching Frequency (kHz)	16, 8	—
Signal Following Input Voltage Range ¹ (Volts DC)	0 – 5	—
Output Frequency Resolution (Bits, Hz)	10, .06	—
Minimum Speed Trimptot (MIN) Range (% Frequency Setting)	0 – 40	0
Maximum Speed Trimptot (MAX) Range (% Frequency Setting)	70 – 110	100
Acceleration Trimptot (ACC) and Deceleration Trimptot (DEC/B) Range (Seconds)	.3 – 20	1.5
Boost Trimptot (DEC/B) Range (50 Hz Only) (Volts/Hz)	0 – 30	5
Slip Compensation Trimptot (COMP) Range at Drive Rating (Volts/Hz)	0 – 3	1.5
Current Limit Trimptot (CL) Range (Amps AC): KBVF-21D	.65 – 1.8	1.6
KBVF-22D	1.0 – 2.8	2.4
KBVF-13, 23, 23D	1.5 – 4.5	3.8
KBVF-14, 24, 24D	2.5 – 7.5	6.4
KBVF-26D	3.5 – 10.5	8.8
Motor Frequency Setting (Hz) (Jumper J1)	50, 60	60
Output Frequency Multiplier (X1, X2) (Jumper J2) ²	1, 2	1
Minimum Operating Frequency at Motor (Hz)	1	—
Speed Range (Ratio)	60:1	—
Speed Regulation (30:1 Speed Range, 0 – Full Load) (% Base Speed) ³	2.5	—
Overload Protector Trip Time for Stalled Motor (Seconds)	6	—
AC Line Input Undervoltage/Overvoltage Trip Points for 115 Volt AC Line (±5%) (Volts AC) ⁴	76 – 141	—
AC Line Input Undervoltage/Overvoltage Trip Points for 208/230 Volt AC Line (±5%) (Volts AC) ⁴	151 – 282	—
Operating Temperature Range (°C / °F)	0 – 45 / 32 – 113	—

Notes: **1.** If a non-isolated signal is used, install the SIVFR – Signal Isolator (Part No. 9597). **2.** Allows the motor to operate up to two times the rated RPM. Constant motor horsepower will result when operating the drive in the "X2" mode above the motor rated frequency. **3.** Dependent on motor performance. **4.** Do not operate the drive outside the specified AC line input voltage operating range.

FIGURE 2A – MODELS KBVF-21D, 22D, 13, 23, 23D MECHANICAL SPECIFICATIONS & CONTROL LAYOUT (Inches/mm) – (Model KBVF-22D Shown)

(See Figure 4, On Page 20, for Expanded View of Jumpers and Trimpots)

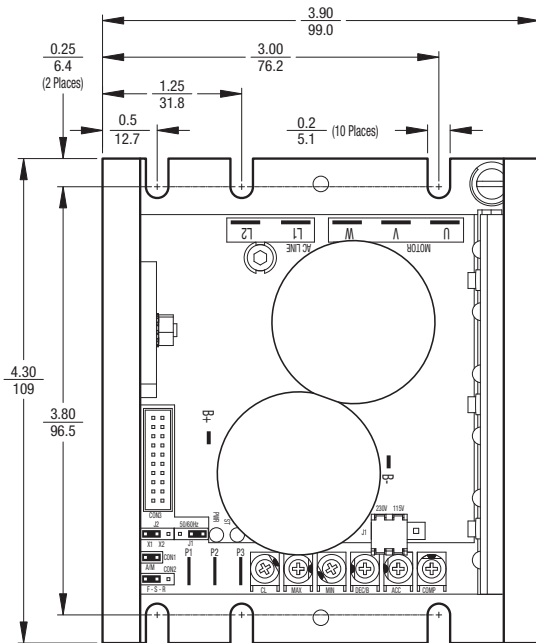

Top View Shown without Finger-Safe Cover Installed

FIGURE 2B – MODELS KBVF-21D, 22D, 13, 23, 23D MECHANICAL SPECIFICATIONS
(Inches/mm) – (Model KBVF-22D Shown)
 (See Figure 4, On Page 20, for Expanded View of Jumpers and Trimpots)

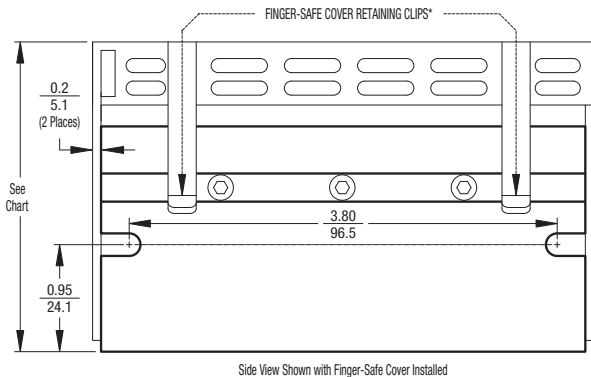

Maximum Height	
Model KBVF-21D	Models KBVF-22D, 13, 23, 23D
2.30 59	2.75 70

* Model KBVF-21D contains internal retaining clips.

FIGURE 3A – MODELS KBVF-14, 24, 24D, 26D MECHANICAL SPECIFICATIONS (INCHES/MM)
(Model KBVF-26D Shown with Finger-Safe Cover Installed)
 (See Figure 4, On Page 20, for Expanded View of Jumpers and Trimpots)

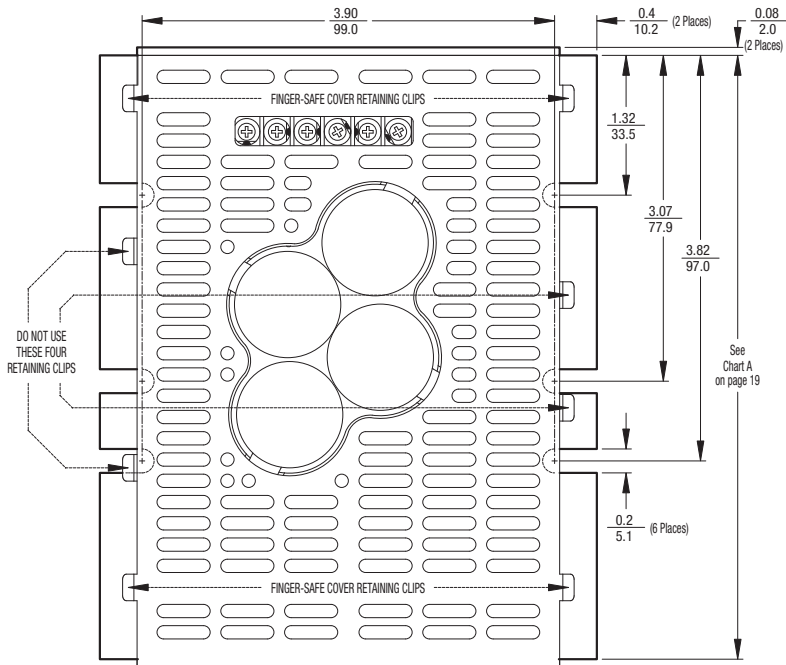

FIGURE 3B – MODELS KBVF-14, 24, 24D, 26D MECHANICAL SPECIFICATIONS (INCHES/MM)
(Model KBVF-26D Shown with Finger-Safe Cover Installed)
 (See Figure 4, On Page 20, for Expanded View of Jumpers and Trimpots)

Chart A - Maximum Length	
Models KBVF-14, 24, 24D	Model KBVF-26D
4.30	5.70
109	145

Chart B - Maximum Height	
Models KBVF-14, 24, 24D	Model KBVF-26D
5.00	4.50
127	114

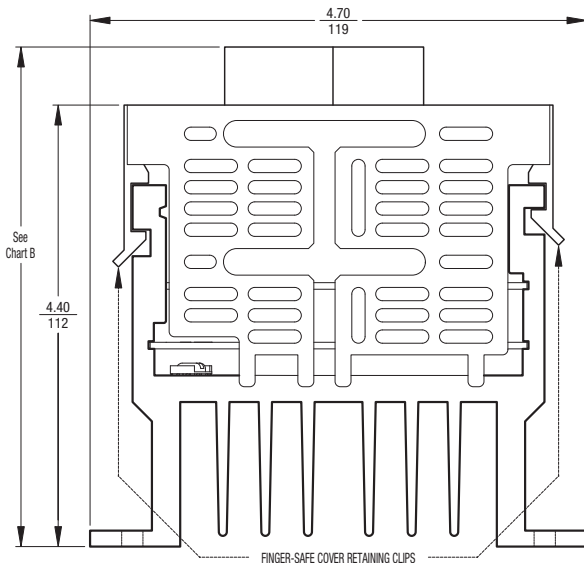
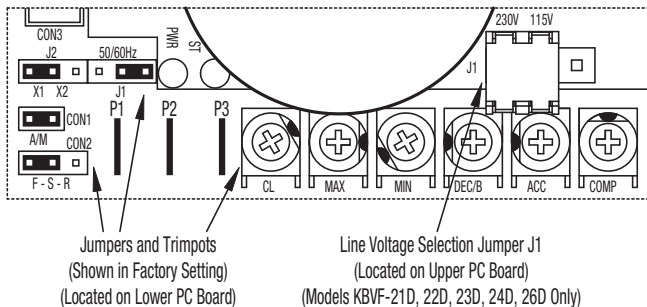

FIGURE 4 – EXPANDED VIEW OF JUMPERS AND TRIMPOTS



4 IMPORTANT APPLICATION INFORMATION

- 4.1 Motor with External Fan Cooling** – Most totally enclosed fan-cooled (TEFC) and open ventilated 3-phase AC induction motors will overheat if used beyond a limited speed range at full torque. Therefore, it is necessary to reduce motor load as speed is decreased.

Note: Some fan-cooled motors can be used over a wider speed range. Consult the motor manufacturer for details.



WARNING! Some motors have low speed characteristics which cause overheating and winding failure under light load or no load conditions. If the motor is operated in this manner for an extended period of time, it is recommended that the unloaded motor current be checked from 2–15 Hz (60 – 450 RPM) to ensure motor current does not exceed the nameplate rating. **Do not use motor if the motor current exceeds the nameplate rating.**



It is recommended that the drive be used with Inverter Duty or TENV motors.

Inverter duty and most totally enclosed non-ventilated (TENV) motors can provide full rated torque over an extended speed range without overheating. See Figure 5.

If external fan cooling is provided, open ventilated motors can also achieve an extended speed range at full rated torque. A box fan or blower with a minimum of 100 CFM is recommended. Mount the fan or blower so the motor is surrounded by the airflow. See Figure 6.

FIGURE 5 – MAXIMUM ALLOWED MOTOR TORQUE VS. SPEED

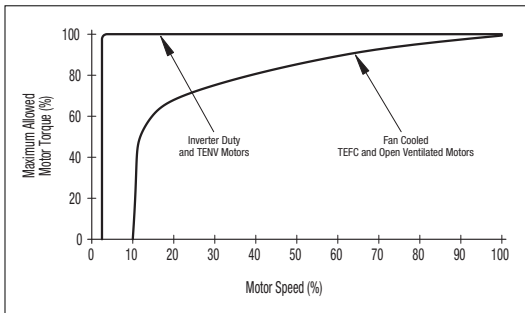
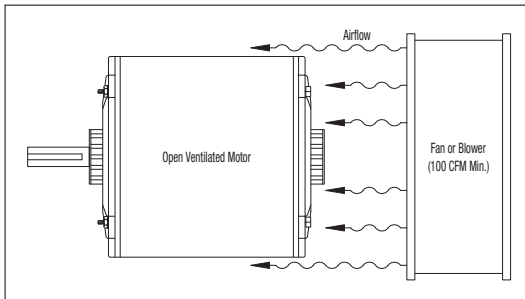

FIGURE 6 – OPEN VENTILATED MOTOR WITH EXTERNAL COOLING



4.2 Electronic Motor Overload Protection – The drive contains Modified I²t Overload Protection.* Part of this function consists of a Current Limit (CL) circuit, which limits the drive current to a factory preset level of 160% of the rated drive current. The CL Trimpot is used to recalibrate the drive current from 60% thru 200%. The Power Start™ circuit provides an over-shoot function that allows most motors to develop more than 200% of starting torque and breakdown torque.

Standard I²t is undesirable because it causes nuisance tripping. It allows a very high motor current to develop and will turn the drive off after a short period of time. KB's RMS Current Limit Circuit avoids this nuisance tripping while providing maximum motor protection.

If the motor is overloaded to 120% of full load (75% of the CL setting), the I²t Timer starts. If the motor continues to be overloaded at the 120% level, the timer will shut down the drive after 30 minutes. If the motor is overloaded to 160% of full load, the drive will trip in 6 seconds.

**UL approved as an overload protector for motors.*

5 FINGER-SAFE COVER

The drive is designed with an IP-20 Finger-Safe Cover which provides protection against accidental contact with high voltage.



WARNING! Disconnect main power when removing or installing the Finger-Safe Cover.



WARNING! To prevent accidental contact with high voltage, it is required that the Finger-Safe Cover be properly installed onto the drive after all wiring and setup is complete. It offers protection against electric shock which limits the potential liability to the equipment manufacturer and installer.

5.1 Removing the Finger-Safe Cover – The Finger-Safe Cover may have to be removed before wiring the drive or setting selectable jumpers. All trimpots can be readjusted with the Finger-Safe Cover installed. Notice the orientation of the Finger-Safe Cover before removing it.

***Note:** The Finger-Safe Cover (except that of the KBVF-21D) is designed with a removable panel (on the trimpots side) which must be removed for installation of optional accessories SIVFR Signal Isolator and Run/Fault Relay (Part No. 9597) or Multi-Speed Board (Part No. 9503). Complete instructions are provided with the accessories.*

Model KBVF-21D – Designed with three “push-ins” (instead of retainer clips) located where the Finger-Safe Cover aligns with the base. To remove the cover, gently press at the three push-ins until the cover disengages from the base.

Models KBVF-22D, 13, 23, 23D, 14, 24, 24D, 26D – To remove the Finger-Safe Cover, gently lift up on the four retainer clips until the cover disengages from the base. See Figures 2B and 3A, on pages 17 and 18.

***Note:** On Model KBVF-26D, the inner bus capacitor support bracket should not be removed.*

5.2 Installing the Finger-Safe Cover – To install the Finger-Safe Cover, be sure to properly align the retainer clips or push-ins. Gently push the Finger-Safe Cover onto the base until the retainer clips or push-ins are fully engaged with the base.

6 SETTING SELECTABLE JUMPERS

The drive has customer selectable jumpers which must be set before the drive can be used. For the location of jumpers, see Figure 4, on page 20.

6.1 AC Line Input Voltage Selection (Jumper J1 (Models KBVF-21D, 22D, 23D, 24D, 26D Only)) –

Jumper J1 is factory set to the “230V” position for 208/230 Volt AC line input. For 115 Volt AC line input, set Jumper J1 to the “115V” position. Jumper J1 is located on the upper PC board. See Figures 7 and 8.

For 115 Volt AC line input, on Model KBVF-26D, the jumper must be removed and installed onto the “115VAC” position. Using pliers, gently rock the female terminal back and forth vertically while pulling it upward. See Figure 9, on page 25.

FIGURE 7 – MODELS KBVF-21D, 22D, 23D, 24D AC LINE INPUT VOLTAGE SELECTION

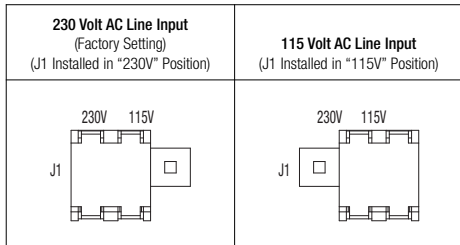
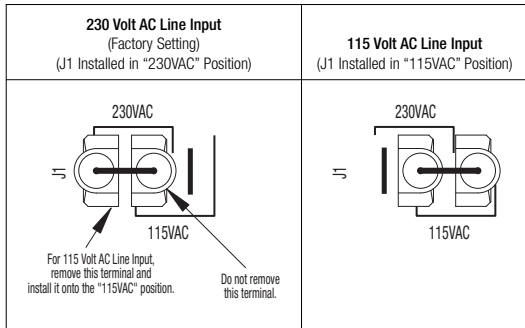

FIGURE 8 – MODEL KBVF-26D AC LINE INPUT VOLTAGE SELECTION



- 6.2 60Hz and 50 Hz Motor Operation and Drive Output Frequency Selection (Jumpers J1 and J2)** – Both jumpers must be set for the appropriate motor nameplate frequency rating. Jumpers J1 and J2 are located on the lower PC board.

- 6.2.1 Setting the Drive for 60 Hz or 50 Hz Motor Operation** – The drive is factory set to operate 60 Hz motors. Jumper J1 is factory set to the “60Hz” position and Jumper J2 is factory set to the “X1” position. For 50 Hz motors, set Jumper J1 to the “50Hz” position, and be sure Jumper J2 is set to the “X1” position. Jumpers J1 and J2 are located on the lower PC board. See Figure 10.

- 6.2.2 Setting the Drive for Two Times the Rated Motor RPM** – The drive can also be used to operate the motor up to two times the rated RPM. However, constant horsepower will result when operating the drive in the “X2” mode above the motor rated frequency. See Figure 11, on page 26.

FIGURE 9 – REMOVING JUMPER J1 ON MODEL KBVF-26D

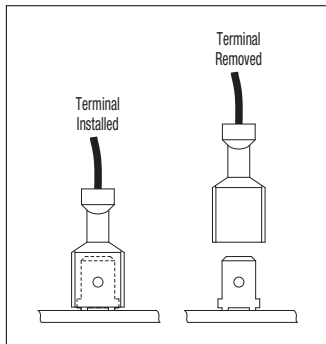
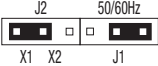
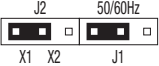

FIGURE 10 – 60 Hz & 50 Hz MOTOR SELECTION

<p>60 Hz Motor Operation (Factory Setting) (J1 Installed in “60Hz” Position) (J2 Installed in “X1” Position)</p>	<p>50 Hz Motor Operation (J1 Installed in “50Hz” Position) (J2 Installed in “X1” Position)</p>
	

For 120 Hz output with 60 Hz motor, be sure Jumper J1 is set to the “60Hz” position and set Jumper J2 to the “X2” position. For 100 Hz output with 50 Hz motor, set Jumper J1 to the “50Hz” position and set Jumper J2 to the “X2” position. See Figure 12.

6.3 Automatic Start (CON1) –

The drive is factory set for Automatic Start (jumper installed onto CON1), as shown in Figure 13, on page 27. CON1 is located on the lower PC board. The drive will automatically start when power is applied and a run command is given. The drive will automatically restart after a *recovered fault* due to undervoltage, overvoltage, or short circuit.

FIGURE 11 – AVAILABLE TORQUE vs. OUTPUT FREQUENCY

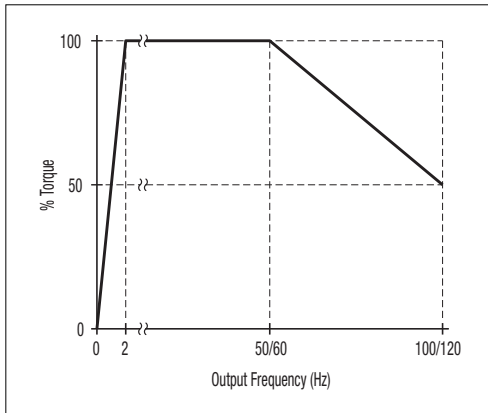

**FIGURE 12 – 120 Hz & 100 Hz
DRIVE OUTPUT FREQUENCY SELECTION**

120 Hz Output with 60 Hz Motor (J1 Installed in “60Hz” Position) (J2 Installed in “X2” Position)	100 Hz Output with 50 Hz Motor (J1 Installed in “50Hz” Position) (J2 Installed in “X2” Position)
<p>J2 50/60Hz</p> <p>X1 X2 J1</p>	<p>J2 50/60Hz</p> <p>X1 X2 J1</p>

For an I²t Trip, due to a prolonged overload, the drive must be *manually* restarted. See Section 11.2, on page 36. Also see Section 12.2, on pages 37 and 38.

For **Manual Start**, a momentary contact must be installed onto CON1, as described in Section 9.6, on pages 33 and 34.

FIGURE 13 – AUTOMATIC START (Jumper Installed)

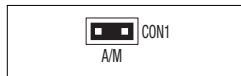

6.4 Forward/Reverse Speed

Selection (CON2) – The drive is factory set for Forward Speed Operation (jumper installed in the “F” position of CON2). CON2 is located on the lower PC board. For Reverse Speed Operation, install the jumper in the “R” position. See Figure 14.

FIGURE 14 – FORWARD/REVERSE SPEED SELECTION

<p>Forward Speed Operation (Factory Setting) (Jumper Installed in “F” Position)</p>	<p>Reverse Speed Operation (Jumper Installed in “R” Position)</p>

To wire a **Forward-Stop-Reverse Switch**, see Section 9.7, on page 34.

7 MOUNTING INSTRUCTIONS



WARNING! This drive must be mounted in an enclosure. Care should be taken to avoid extreme hazardous locations where physical damage to the drive can occur due to moisture, metal chips, dust, and other contamination, including corrosive atmosphere that may be harmful. See Safety Warning on pages 8 and 9. To prevent accidental contact with high voltage, it is required that the Finger-Safe Cover be properly installed onto the drive after all wiring and set up is complete. Do not use this drive in an explosion-proof application.

Application Note – The enclosure should be large enough to allow for proper heat dissipation so that the ambient temperature does not exceed 45 °C (113 °F). Leave enough room to allow for AC line, motor connection, and other wiring that is required. See Figures 2A, 2B, 3A and 3B, on pages 16 –19.

When mounting the Main Speed Potentiometer, be sure to install the insulating disc between the potentiometer and the panel.

8 RECOMMENDED HIGH VOLTAGE DIELECTRIC WITHSTAND TESTING (HI-POT TESTING)

Testing agencies such as UL, CSA, etc., usually require that equipment undergo a hi-pot test. In order to prevent catastrophic damage to the drive, which has been installed in the equipment, the following procedure is recommended. A typical hi-pot test setup is shown in Figure 15, on page 29.

All drives have been factory hi-pot tested in accordance with UL requirements.



Warning! All equipment AC line inputs must be disconnected from the AC power.

- 8.1 Connect all equipment AC power input lines together and connect them to the H.V. lead of the Hi-Pot Tester. Connect the RETURN of the Hi-Pot Tester to the frame on which the drive and other auxiliary equipment are mounted.
- 8.2 The Hi-Pot Tester must have an automatic ramp-up to the test voltage and an automatic ramp-down to zero voltage.

Note: *If the Hi-Pot Tester does not have automatic ramping, then the hi-pot output must be manually increased to the test voltage and then manually reduced to zero. This procedure must be followed for each machine being tested. A suggested Hi-Pot Tester is Slaughter Model 2550.*

CAUTION! Instantly applying the hi-pot voltage will cause irreversible damage to the drive, which will void the warranty.

FIGURE 15 – TYPICAL HI-POT SETUP

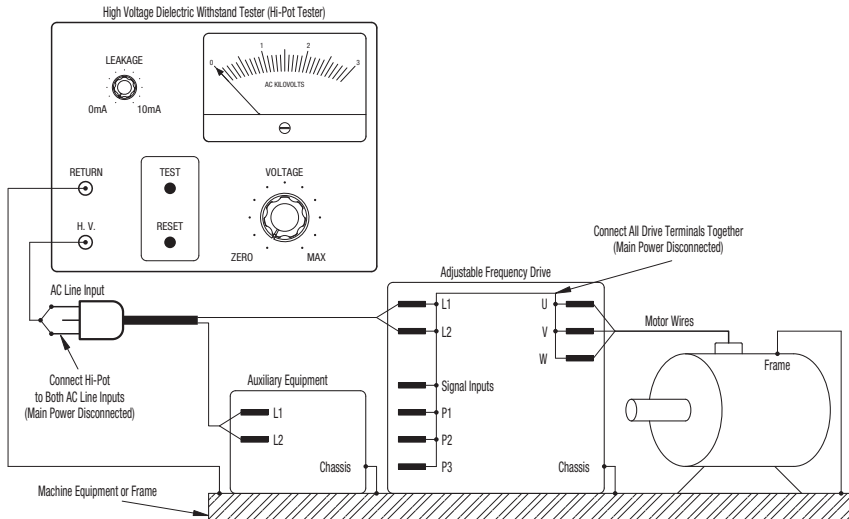

9 WIRING INSTRUCTIONS



WARNING! Read Safety Warning, on pages 8 and 9, before using the drive.

Disconnect main power when making connections to the drive. To avoid electric shock, be sure to properly ground the drive.

Application Note – To avoid erratic operation, do not bundle the AC line and motor wires with each other or with wires from signal following, start/stop contacts, or any other signal wires. Also, do not bundle motor wires from multiple drives in the same conduit. Use shielded cables on all signal wiring over 12" (30 cm). The shield should be earth grounded on the drive side only. Wire the drive in accordance with the National Electrical Code requirements and other local codes that may apply.

Be sure to properly fuse each AC line conductor that is not at ground potential. Do not fuse neutral or grounded conductors. A separate AC line switch or contactor must be wired as a disconnect so that each ungrounded conductor is opened. For fuse or circuit breaker selection, see Table 1, on page 14. Also see section 10, on page 35.

9.1 AC Line Connection – Wire the single-phase AC line input to Terminals “L1” and “L2”. The terminals are located on the upper PC board. See Figure 16, on page 31.

GFCI Operation – Do not connect this drive to an AC power source controlled by a Ground Fault Circuit Interrupter. Special software is available for GFCI operation – contact our Sales Department.

Models KBVF-13, 14 – Rated for 115 Volt AC line input only.

Models KBVF-23, 24 – Rated for 208/230 Volt AC line input only.

Models KBVF-21D, 22D, 23D, 24D, 26D* – Rated for 208/230 Volt AC line input with Jumper J1 set to the “230V” position (factory setting). Rated for 115 Volt AC line input with Jumper J1 set to the “115V” position. Jumper J1 is located on the upper PC board.

30 **Note:** Be sure Jumper J1 is set to the correct AC line input voltage.

***Note:** On Model KBVF-26D, Jumper J1 is labeled “115VAC” and “230VAC”.

9.2 Ground Connection –

Connect the ground wire (earth) to the green ground screw. The ground screw is located on the heat sink. The ground screw is located on the heat sink. See Figure 16.

Note: Model KBVF-21D, due to its double insulated design, does not contain a ground screw.

- ### 9.3 Motor Connection –
- Wire the motor to Terminals “U”, “V”, “W”. The terminals are located on the upper PC board. See Figure 16. Motor cable length should not exceed 100 ft. (30 m) – special reactors may be required – consult our Sales Department.

Note: The drive is programmed to operate 3-phase AC induction motors. For PSC motors, optional software is required – contact our Sales Department.

- ### 9.4 Main Speed Potentiometer Connection –
- The drive is supplied with a 5 k Ω Main Speed Potentiometer to control motor speed. Wire the Main Speed Potentiometer to Terminals “P1” (low), “P2” (wiper), “P3” (high). The terminals are located on the lower PC board. See Figure 17, on page 32.

FIGURE 16 – AC LINE INPUT, MOTOR, & GROUND CONNECTIONS

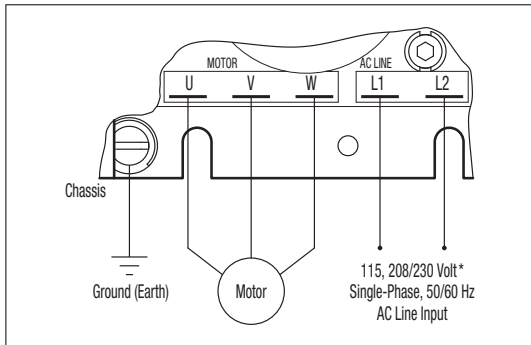



WARNING! Do not
earth ground any Main
Speed Potentiometer terminals.

Note: When mounting the Main Speed Potentiometer, be sure to install the insulating disc (supplied) between the potentiometer and the panel.

9.5 Voltage Following Connection –

An *isolated** 0 – 5 Volt DC analog signal input can be used to control motor speed in lieu of the Main Speed Potentiometer. The drive output will linearly follow the analog

signal input. Connect the signal input positive lead (+) to Terminal “P2” and the negative lead (–) to Terminal “P1”. The terminals are located on the lower PC board. With external circuitry, a 0 – 10 Volt DC analog signal can also be used. See Figure 18, on page 33.

**If a non-isolated signal is used, install the SIVFR — Signal Isolator (Part No. 9597). The SIVFR accepts voltage (0 to ± 2.5 thru 0 to ± 25 Volts DC) or current (4 – 20 mA DC) signal inputs. See Section 3.5, on page 13.*

Note: For signal following operation, the Minimum Speed Trimpot (MIN) must be set fully counterclockwise.

FIGURE 17 – MAIN SPEED POTENTIOMETER CONNECTION

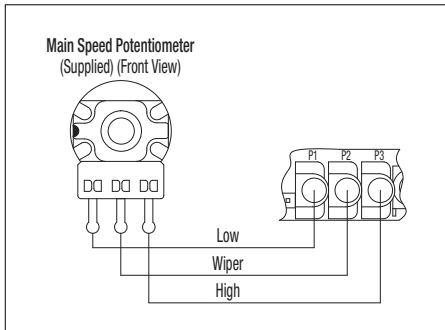



WARNING! The signal input must be isolated from the AC line. Earth grounding signal wiring will damage the drive and void the warranty. It is recommended that the SIVFR — Signal Isolator and Run/Fault Relay (Part No. 9597) be installed when using signal following.

9.6 Manual Start Switch

Connection (CON1) – The Manual Start Mode is used to manually start the drive or restart the drive (reset) if a fault has occurred. To operate the drive in the Manual Start Mode, remove the factory installed jumper on CON1 and install the 2-wire connector (supplied).

CON1 is located on the lower PC board. The connector must be wired to a momentary switch or contact, as shown in Figure 19, on page 34.

In the Manual Start Mode, the drive will trip due to all faults (Overvoltage, Undervoltage, Short Circuit, and I²t) and remain tripped even when the fault is cleared. To Start/Reset the drive, the switch or contact must be manually closed. Also, the drive must be restarted each time the AC line is interrupted.

For **Automatic Start**, see Section 6.3, on pages 26 and 27.

Notes: **1.** See Section 11.2, on page 36. Also see Section 12.2, on pages 37 and 38. **2.** The drive can be factory programmed for Run/Stop operation with momentary contacts.

FIGURE 18 – VOLTAGE FOLLOWING CONNECTION

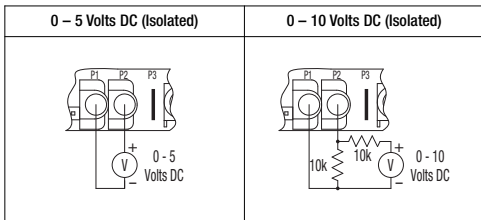

9.7 Forward-Stop-Reverse Switch Connection (CON2)

– To operate the drive using a Forward-Stop-Reverse Switch, remove the factory installed jumper on CON2 and install the 3-wire connector (supplied). CON2 is located on the lower PC board. The connector must be wired to a “maintained” switch or contact. See Figure 20. Also see **Forward/Reverse Speed Selection**, in Section 6.4, on page 27.

Note: *The drive can be factory programmed for momentary contact operation.*

9.8 Enable Switch Connection (CON2)

The drive can be started and stopped with an Enable Switch (close to run, open to stop). Remove the factory installed jumper on CON2 and install the 3-wire connector (supplied). CON2 is located on the lower PC board. The connector must be wired to a “maintained” switch or contact. See Figure 21, on page 35.

FIGURE 19 – MANUAL START SWITCH CONNECTION

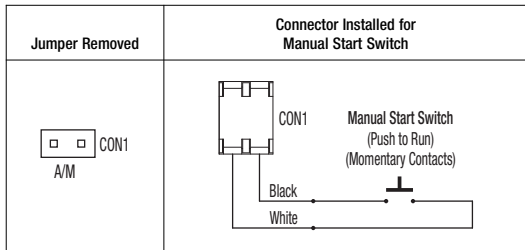
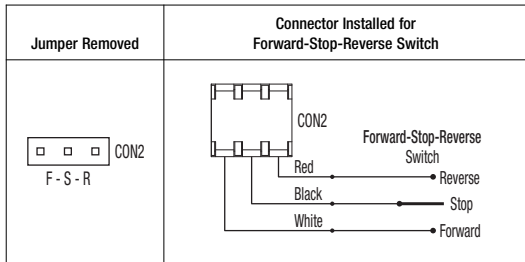
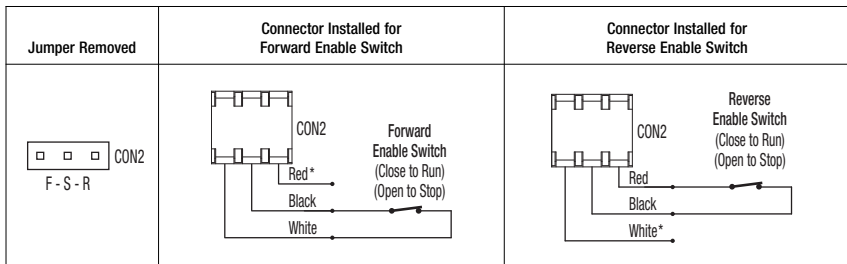

FIGURE 20 – FORWARD-STOP-REVERSE SWITCH CONNECTION



For **Forward Enable Operation**, wire the switch to the white and black wires. For **Reverse Enable Operation**, wire the switch to the red and black wires. When the switch is closed, the drive will run. When the switch is opened, the drive will stop.

FIGURE 21 – ENABLE SWITCH CONNECTION



**For Forward Enable Switch connection, the red wire is not used. For Reverse Enable Switch connection, the white wire is not used. The unused wire must be insulated or it may be cut off at the connector.*

10 AC LINE FUSING

This drive does not contain AC line fuses. Most electrical codes require that each ungrounded conductor contain circuit protection. **Do not fuse neutral or ground connections.** It is recommended to install a fuse (Littelfuse 326, Buss ABC, or equivalent) or a circuit breaker in series with each ungrounded conductor. **Do not fuse motor leads.** For the recommended fuse size, see Table 1, on page 14. Wire the drive in accordance with the National Electrical Code requirements and other local codes that may apply to the application.

11 DRIVE OPERATION

11.1 Start-Up Procedure – After the drive has been properly setup (jumpers and trimpots set to the desired positions) and wiring completed, the startup procedure can begin. If the AC power has been properly brought to the drive, the power (PWR) LED will be illuminated green. The status (ST) LED will indicate drive status, as described in Section 11.2. To remove and install the Finger-Safe Cover, see Section 5, on pages 22 and 23.

11.2 Fault Recovery – The drive monitors four faults (Undervoltage, Overvoltage, Short Circuit at the motor (phase-to-phase), I^2t). Table 3, describes how the drive will automatically start (factory setting) after the fault has cleared.

Application Note: In Manual Start Mode, the drive must be manually reset for any fault. Use the Manual Start Switch, as described in Section 9.6, on pages 33 and 34. Also see Section 12.2, on pages 37 and 38.

TABLE 3 – FAULT RECOVERY AND RESETTING THE DRIVE*

Fault	Automatic Start Mode (Factory Setting)
Undervoltage	Drive will automatically start after the bus voltage returns to the operational level or when the drive is first turned on (power up).
Overvoltage	Drive will automatically start after the bus voltage returns to the operational level.
Short Circuit	Drive will automatically start after the short circuit is removed.
I^2t	Drive must be manually restarted .

**The fault must be cleared before the drive can be reset.*

11.3 Restarting the Drive After an I²t Fault Has Cleared – The drive can be restarted after an I²t Fault has cleared by any of the following methods.

Note: *If an I²t Fault occurs, the motor may be overloaded. Check the motor current with an AC RMS responding ammeter. Also, the CL setting may be set too low. See Section 13.7, on pages 42 and 43.*

1 Disconnect and reconnect the AC power (approximately 15 seconds). The “ST” LED must change from quick flashing red to flashing red/yellow.

2 Set the Main Speed Potentiometer to zero (fully counterclockwise).

Note: *In order to be able to reset the drive by setting the Main Speed Potentiometer to zero, it is necessary to have the MIN Trimpot set to zero (fully counterclockwise).*

3 Open and close the Enable switch or contact. See Section 9.8, on pages 34 and 35.

12 DIAGNOSTIC LEDES

The drive contains two diagnostic LEDs to display the drive's operational status. See Figure 4, on page 20, for the location of the “PWR” and “ST” LEDs.

12.1 Power On (PWR) – The “PWR” LED will illuminate green when the AC line is applied to the drive.

12.2 Status LED (ST) – The “ST” LED is a tricolor LED which provides indication of a fault or abnormal condition. The information provided can be used to diagnose an installation problem such as incorrect input voltage, overload condition, and drive output miswiring. It also provides a signal which informs the user that all drive and microcontroller operating parameters are normal. Table 4, on page 38, summarizes the “ST” LED functions.

Note: The drive is factory set to the Automatic Start Mode. For Manual Start/Rest, see Section 9.6, on pages 33 and 34.

13 TRIMPOT ADJUSTMENTS

The drive contains trimpots which are factory set for most applications. See Figure 4, on page 20, for the location of the trimpots and their approximate factory calibrated positions. Some applications may require readjustment of the trimpots in order to tailor the drive for a specific requirement. The trimpots may be readjusted as described below.



WARNING! If possible, do not adjust trimpots with the main power applied. If adjustments are made with the main power applied, an insulated adjustment tool must be used and safety glasses must be worn. High voltage exists in this drive. Fire and/or electrocution can result if caution is not exercised. Safety Warning, on pages 8 and 9, must be read and understood before proceeding.

TABLE 4 – DRIVE OPERATING CONDITION & STATUS LED INDICATOR

Drive Operating Condition	Flash Rate ¹ and LED Color
Normal Operation	Slow Flash Green
Overload (120% – 160% Full Load)	Steady Red ²
I ² t (Drive Timed Out)	Quick Flash Red
Short Circuit	Slow Flash Red
Undervoltage	Quick Flash Red / Yellow ³
Overvoltage	Slow Flash Red / Yellow ³
Stop	Steady Yellow

Notes: 1. Slow Flash = 1 second on and 1 second off. Quick Flash = 0.25 second on and 0.25 second off. 2. In Manual Start Mode, when the Overload is removed, before the I²t times out and trips the drive, the “ST” LED will flash green. 3. In Manual Start Mode, when the Undervoltage or Overvoltage condition is corrected, the “ST” LED will flash Red / Yellow / Green.

13.1 Minimum Speed (MIN) – Sets the minimum speed of the motor. The MIN Trimpot is factory set to 0% of frequency setting. For a higher minimum speed setting, rotate the MIN Trimpot clockwise. See Figure 22.

13.2 Maximum Speed (MAX) – Sets the maximum speed of the motor. The MAX Trimpot is factory set to 100% of frequency setting. For a higher maximum speed setting, rotate the MAX Trimpot clockwise. For a lower maximum speed setting, rotate the MAX Trimpot counterclockwise. See Figure 23.

13.3 Acceleration (ACC) – Sets the amount of time for the motor to accelerate from zero speed to full speed. The ACC Trimpot is factory set to 1.5 seconds. For longer acceleration time, rotate the ACC Trimpot clockwise. For more rapid acceleration, rotate the ACC Trimpot counterclockwise. See Figure 24.

***Note:** Rapid acceleration settings may cause the current limit circuit to activate, which will extend the acceleration time.*

13.4 Deceleration (DEC/B) – Sets the amount of time for the motor to decelerate from full speed to zero speed. The DEC/B Trimpot is factory set to 1.5 seconds. For longer deceleration time, rotate the DEC/B Trimpot clockwise. For more rapid deceleration, rotate the DEC/B Trimpot counterclockwise. See Figure 25, on page 40.

FIGURE 22 – MINIMUM SPEED TRIMPOT (MIN) RANGE

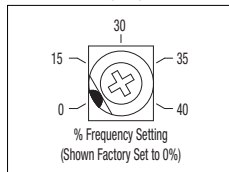

FIGURE 23 – MAXIMUM SPEED TRIMPOT (MAX) RANGE

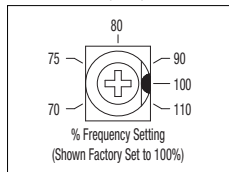
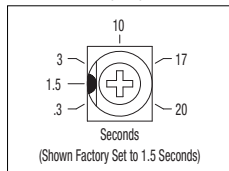

FIGURE 24 – ACCELERATION TRIMPOT (ACC) RANGE



Application Note – On applications with high inertial loads, the deceleration may automatically increase in time. This will slow down the rate of speed of decrease to prevent the bus voltage from rising to the Overvoltage Trip point. This function is called Regeneration Protection. **It is recommended that for very high inertial loads that both the ACC and DEC/B Trimpots should be set to greater than 10 seconds.**

For rapid stopping, install the optional DBVF — Dynamic Brake Module (Part No. 9598). See Section 3.5, on page 13.

- 13.5 Slip Compensation (COMP)** – Sets the amount of Volts/Hz to maintain set motor speed under varying loads. The COMP Trimpot is factory set to 1.5 Volts/Hz, which provides excellent speed regulation for most motors. To increase the slip compensation, rotate the COMP Trimpot clockwise. To decrease the slip compensation, rotate the COMP Trimpot counterclockwise. See Figure 26.

The slip compensation may be adjusted as follows:

1. Wire an AC RMS ammeter in series with one motor phase.
2. Run the motor and set the unloaded speed to approximately 50% (900 RPM on 4-pole 1500/1725 RPM motors).
3. Using a tachometer, record the unloaded speed.
4. Load the motor to the nameplate rated current (Amps AC).

FIGURE 25 – DECELERATION TRIMPOT (DEC/B) RANGE

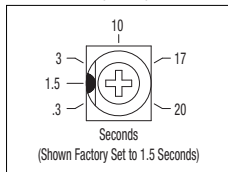

FIGURE 26 – SLIP COMPENSATION TRIMPOT (COMP) RANGE

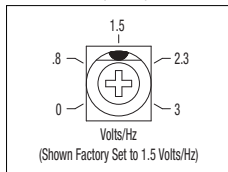
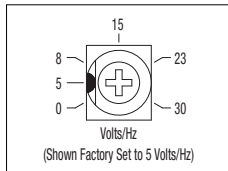

FIGURE 27 – BOOST TRIMPOT (DEC/B) RANGE



5. Adjust the COMP Trimpot until the loaded RPM is equal to the unloaded RPM.
6. The motor is now compensated to provide constant speed under varying loads.

13.6 Boost (DEC/B) – When the drive is set for 50 Hz Motor Operation (Jumper J1 installed in the “50Hz” position), the DEC/B Trimpot automatically becomes the adjustable BOOST Trimpot.

Most 60 Hz motors conforming to NEMA standards can operate from a preset Volts/Hz curve. 50 Hz motors, however, generally differ widely in their characteristics. Therefore, it is necessary to have adjustable Boost to obtain maximum motor performance.

To increase the boost, rotate the BOOST Trimpot clockwise. To decrease the boost, rotate the BOOST Trimpot counterclockwise. See Figure 27, on page 40.

In order for the 50 Hz motor to run properly, the boost must be adjusted. If the application does not require full torque below 10 Hz, the Boost (DEC/B) Trimpot can be conservatively set at 8% (9 o'clock position).

Note: *In 50 Hz motor operation, the deceleration time is automatically set to the same as the Acceleration Trimpot (ACC) setting.*



WARNING! To avoid motor winding heating and failure, do not overboost the motor.

The Boost (DEC/B) Trimpot may be adjusted as follows:

1. Wire an AC RMS ammeter in series with one motor phase.
2. Run the motor unloaded at approximately 4 Hz (or 120 RPM).

Note: *An unloaded motor with excessive boost will draw more current than a partially loaded motor.*

3. Increase the boost until the ammeter reaches the nameplate rated current (Amps AC).
4. Using the Main Speed Potentiometer, slowly adjust the motor speed over a 0 – 15 Hz (0 – 450 RPM) range. If the motor current exceeds the nameplate rating, decrease the boost setting.

13.7 Motor Overload (I²t) with RMS Current Limit (CL)* – Sets the current limit (overload), which limits the maximum current to the motor, prevents motor burnout, and eliminates nuisance trips. The CL Trimpot is factory set to 160% of the drive rating. To increase the current limit, rotate the CL Trimpot clockwise. To decrease the current limit, rotate the CL Trimpot counterclockwise. See Figures 28 – 32, on page 43.

**UL approved as an electronic overload protector for motors.*

In order to ensure that the motor is properly protected with the I²t feature, it is required that the CL Trimpot be set for 160% of the motor nameplate rating. This is accomplished as follows:

Note: *This adjustment must be made within 6 seconds or the I²t Trip will occur.*

1. Wire an AC RMS ammeter in series with one motor phase.
2. Set the CL Trimpot fully counterclockwise.
3. Adjust the speed setting to 30% of full speed.
4. Lock the motor shaft and adjust the CL Trimpot to 160% of the motor nameplate rating.

Example: A 1/2 HP motor has a full load current rating of 1.8 Amps. Set the CL Trimpot to $1.8 \times 160\% = 2.9$ Amps.

**FIGURE 28 – MODEL KBVF-21D
CURRENT LIMIT TRIMPOT (CL) RANGE**

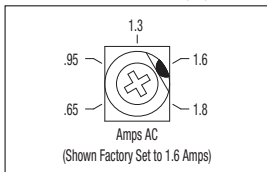

**FIGURE 29 – MODEL KBVF-22D
CURRENT LIMIT TRIMPOT (CL) RANGE**

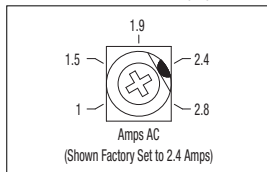

**FIGURE 30 – MODELS KBVF-13, 23, 23D
CURRENT LIMIT TRIMPOT (CL) RANGE**

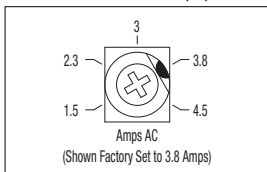

**FIGURE 31 – MODELS KBVF-14, 24, 24D
CURRENT LIMIT TRIMPOT (CL) RANGE**

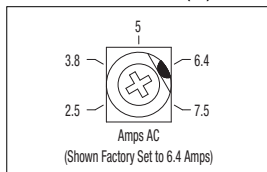

**FIGURE 32 – MODEL KBVF-26D
CURRENT LIMIT TRIMPOT (CL) RANGE**

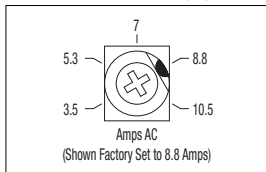

LIMITED WARRANTY

For a period of 18 months from the date of original purchase, KB Electronics, Inc. will repair or replace without charge, devices which our examination proves to be defective in material or workmanship. This warranty is valid if the unit has not been tampered with by unauthorized persons, misused, abused, or improperly installed and has been used in accordance with the instructions and/or ratings supplied. The foregoing is in lieu of any other warranty or guarantee, expressed or implied. KB Electronics, Inc. is not responsible for any expense, including installation and removal, inconvenience, or consequential damage, including injury to any person, caused by items of our manufacture or sale. Some states do not allow certain exclusions or limitations found in this warranty and therefore they may not apply to you. In any event, the total liability of KB Electronics, Inc. under any circumstance, shall not exceed the full purchase price of this product. (rev 2/2000)

COPYRIGHT © 2005 KB Electronics, Inc.

All rights reserved. In accordance with the United States Copyright Act of 1976, no part of this publication may be reproduced in any form or by any means without permission in writing from KB Electronics, Inc. (8/2002)



KB ELECTRONICS, INC.

12095 NW 39th Street, Coral Springs, FL 33065-2516 • (954) 346-4900 • FAX (954) 346-3377

Outside Florida Call Toll Free (800) 221-6570 • info@kbelectronics.com

www.kbelectronics.com