

INSTALLATION INSTRUCTIONS 07401145

Model 0928 Shaft Kit

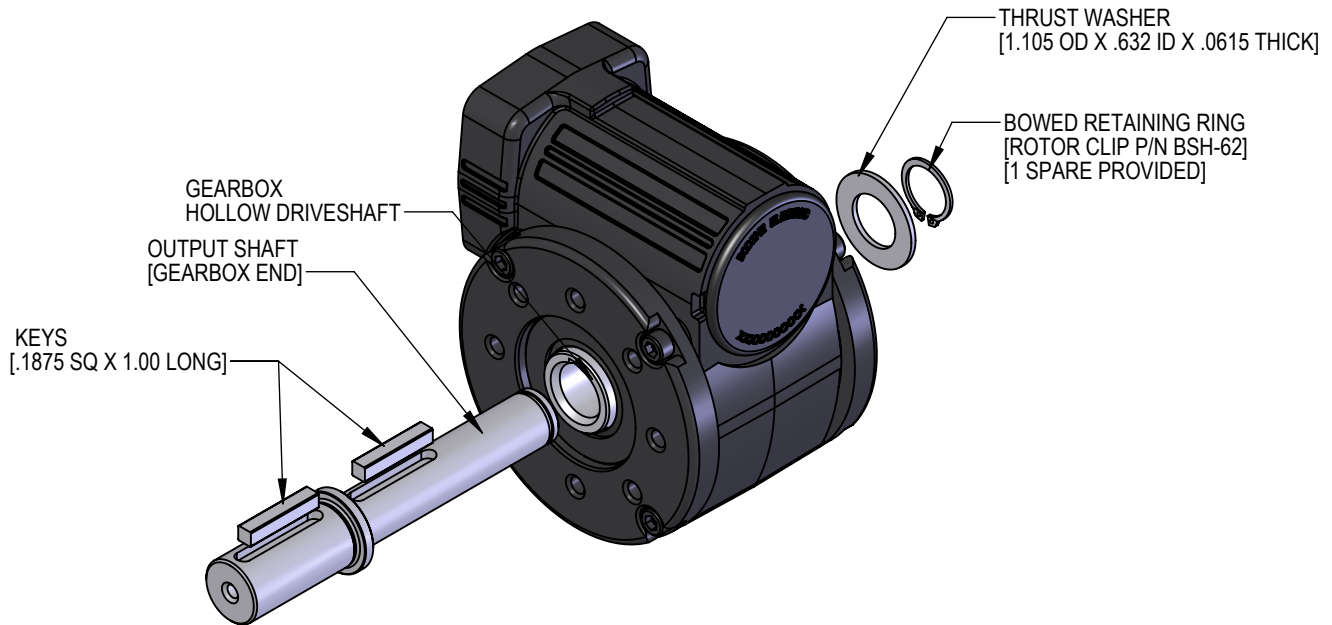

1. Insert key into keyway on gearbox end of output shaft.
2. Align key to keyway and insert the output shaft into the gearbox hollow driveshaft.
3. With output shaft shoulder flush to end of hollow driveshaft, install thrust washer and secure bowed retaining ring* in groove as shown in Detail A below. (Tip: You can use a 5/8 socket to help push retaining ring securely into groove if using the installation pliers is not successful to fully seat the retaining ring)

*RECOMMENDED INSTALLATION PLIERS FOR RETAINING RING: ROTOR CLIP RP-200, GRAINGER #3R319, MCMaster #5415A62

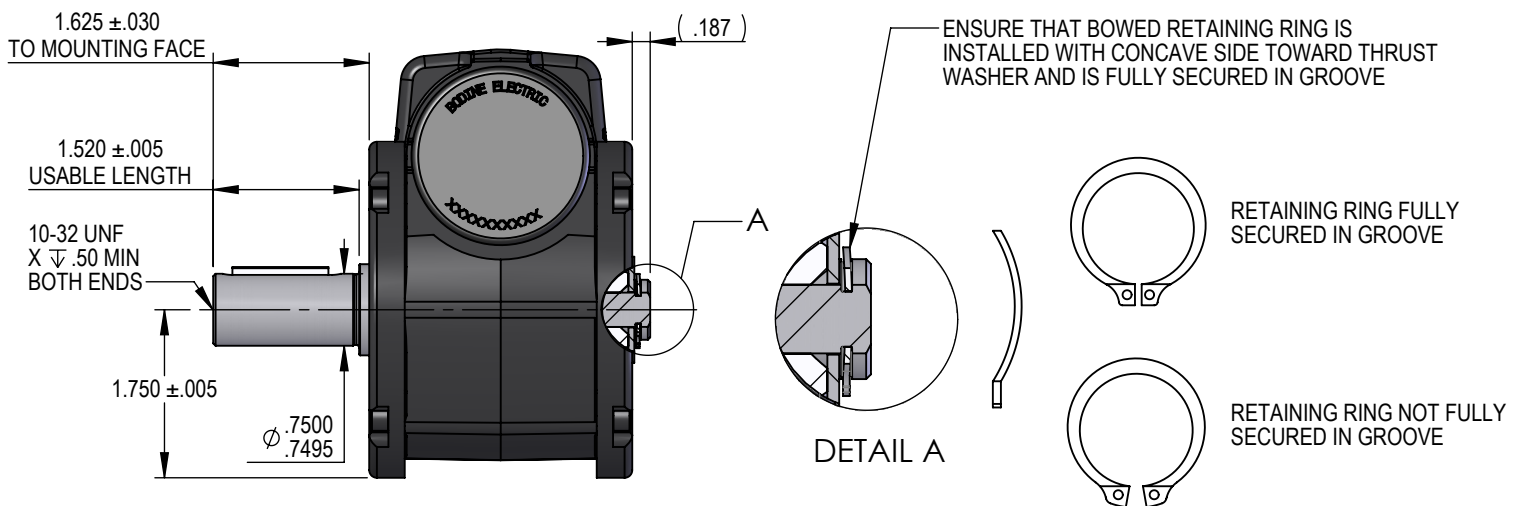

BODINE**ELECTRIC****COMPANY**

Gearmotor/Motor Safety, Installation, Use, and Maintenance Information



Thank you for selecting a gearmotor/motor from Bodine Electric Company. With your new drive unit you will find yourself enjoying the same high performance and trouble free operation that has been characteristic of Bodine products since 1905.

Bodine Electric Company prides itself on the quality of design and manufacture of its products. Great care is taken in an attempt to provide products free of defects in workmanship, or materials.

Safety

"The use of electric machines, like that of all other utilization of concentrated power, is potentially hazardous. The degree of hazard can be greatly reduced by proper design, selection, installation, and use, but hazards cannot be completely eliminated. The reduction of hazard is the joint responsibility of the user, the manufacturer of the driven or driving equipment, and the manufacturer of the machine".

Bodine products are designed and manufactured to comply to applicable safety standards and, in particular, to those issued by ANSI (American National Standards Institute), NEMA (National Electrical Manufacturers Association), U.L. (Underwriters Laboratories, Inc.), and CSA (Canadian Standards Association).

Most Bodine products are "third party approved" with respect to construction. Motors and gearmotors having component recognition by U.L. Inc. have a  symbol on their nameplates. Those that are CSA certified also have a  or a  mark in the same location. If you need specific information regarding the "third party approval" of Bodine products, contact your Bodine Representative, or the Corporate Headquarters.

However, since even well built apparatus can be installed or operated in a hazardous manner, it is important that the users observe safety considerations. With respect to the load and environment, the user must properly *select, install, and use* the apparatus—for guidance on all three aspects see safety standards publication No. ANSI/NEMA MG-2.*

* Standards Publication No. ANSI/NEMA MG-2. "Safety Standard for Construction and Guide for Selection, Installation and Use of Electric Motors and Generators."

Available from:
National Electrical Manufacturers Assoc.
www.nema.org

Selection

Before proceeding with the installation, the user should review the application to confirm that the proper drive has been selected. This should be done after reading this notice and all applicable safety standards. If in doubt, contact your Bodine Representative or the Corporate Headquarters if there is no Representative in your area. Any selection or application suggestions made by Bodine or their Representatives are only to assist the customer—and in all cases, determination of fitness for purpose or use is solely the customer's responsibility.

All nameplate ratings are based on the following *normal operating conditions*:

1. Duty: 8 hours per day; 5 days per week if nameplate continuous duty (CONT), without frequent reversals or starts and stops.
2. Ambient temperature 0°C to 40°C, unless otherwise noted on the product nameplate.
3. Load: Uniform and free from shock or high inertia.
4. Voltage: Within 10% of nameplate rating.
5. Frequency: Within 5% of nameplate rating.
6. Combined variation of voltage and frequency—Within a total of 10% providing frequency variation does not exceed 5%.

Variations from the above conditions may be hazardous.

Installation

It is the responsibility of the equipment manufacturer or individual installing the apparatus to take diligent care in installing it. The National Electrical Code (NEC), sound local electrical and safety codes, and when applicable, the Occupational Safety and Health Act (OSHA) should be followed when installing the apparatus to reduce hazards to persons and property.

Inspection

Examine the apparatus for damage from shipment before connecting. Any claim(s) for shipping damage should be made to the freight carrier. Do not attempt to turn the output shaft of a gearmotor with an externally applied torque arm. Paint thickness of .006 maximum does not apply to published dimensional values.

Mounting

Any screws or similar devices, that penetrate the motor frame either for mounting the Bodine product or mounting something to the product, should be limited in length so as not to come in contact with, or in close proximity to, intended features that conduct electricity.

Bodine stock products are designed for universal horizontal mounting. Vertical mounting, with gearhead above motor is not normally recommended. Consult the factory for custom mounting requirements.

Connection

Follow nameplate for voltage, frequency, and phase of power supply. See accompanying wiring diagram as to connections for rotation (and capacitor, resistor, relay, protector, if required).

When connecting, make sure that your motor/gearmotor is securely and adequately grounded—failure to ground properly may cause serious injury to personnel. Wiring diagrams are available at: www.bodine-electric.com

Wiring

For wire sizes and electrical connections refer to the National Electrical Code (NEC), Article 430, "Motors, Motor Circuits, and Controllers" and/or applicable local area codes. Extension cords should not be used.

Use

Additional Safety Considerations

The chance of electric shock, fires, or explosions can be reduced by giving proper consideration to the use of grounding, thermal and over current protection, type of enclosure, and good maintenance procedures.

The following information *supplements* the foregoing safety considerations: This information is not purported to be all-inclusive and the aforementioned references should be consulted.

1. Bodine standard totally enclosed products are neither explosion proof nor dust ignition proof and are not certified for hazardous locations in the presence of flammable/explosive gas, vapor, or dust. When dealing with hazardous locations, an approved or certified product is generally the recommended approach. The NEC and NEMA safety standards should be consulted to determine if exceptions are allowed.
2. Enclosed motors/gearmotors are suitable for dirty, damp locations. For outdoor use, enclosed motors must be protected by a IP-44 sealing kit or a cover while still allowing adequate airflow.

3. Moisture will increase the electrical shock hazard of electrical insulation. Therefore, consideration should be given to the avoidance of (or protection from) liquids in the area of motors. Use of totally enclosed motors/gearmotors will reduce the hazard if all openings are sealed.
4. Motors/gearmotors that employ capacitors can develop more than nameplate voltage across the capacitor and/or capacitor winding (depending on design). Suitable precautions should be taken when applying such motors.
5. Do not rely upon self-locking gears or permanent magnet, or energized motors to hold a load in place if movement could result in personal injury. Mechanical locking devices should be used in such applications.
6. For motors driven by electronic controls, do not use a function of the control for safety interlock purposes. An independent switch or relay should be used.

Before Starting

1. Before attempting to start, check all connections and fuses.
2. Proper consideration should be given to rotating members: Before starting, be sure keys, pulleys, etc. are securely fastened. *Proper guards should be provided to prevent hazards to personnel while rotating.*
3. Other mechanical considerations include proper mounting and alignment of products and safe loads on shafting and gearing.

Starting

1. The motor/gearmotor should be test-started in an unloaded state (because of possible reaction torque, the drive should be securely mounted when starting—even when unloaded).
2. If the drive unit does not start promptly and run smoothly, disconnect immediately.
3. If unable to correct the problem, contact your purchase source, or a Bodine Authorized Service Center, describing the trouble in detail. Include the serial number, type, and other nameplate data. Do not dismantle the product—tampering or disassembly voids the warranty.

Maintenance

IMPORTANT—*Before* servicing or working on equipment, disconnect power source (this applies especially to equipment using automatic restart devices instead of manual restart devices and when examining or replacing brushes on brush-type motors/gearmotors).

Clean regularly to prevent dirt and dust from interfering with ventilation or clogging moving parts.

Brush-Type Motors/Gearmotors—For optimum performance, brush-type motors and gearmotors need periodic user-maintenance. The maintenance interval is best determined by the user. Inspect brushes regularly for wear (replace in same axial position). Replace brushes as needed.

Products Employing Capacitors—Before servicing motors/gearmotors employing capacitors, always discharge the capacitor by placing a conductor across its terminals before touching the terminals with any part of your body.

Lubrication

All Bodine products are lubricated for life, and do not require re-lubrication. (All information and data are subject to change without notice.)