

DESCRIPTION: MOTOR 24A4BEPM	
SHEET: 1/1	UNLESS OTHERWISE SPECIFIED:
SCALE: 1:1	UNITS ARE IN INCHES [mm]
C	TOLERANCES: .XX:±.01 .XXX:±.005
	ANGLES: X°:±3° X.X°:±0.5°

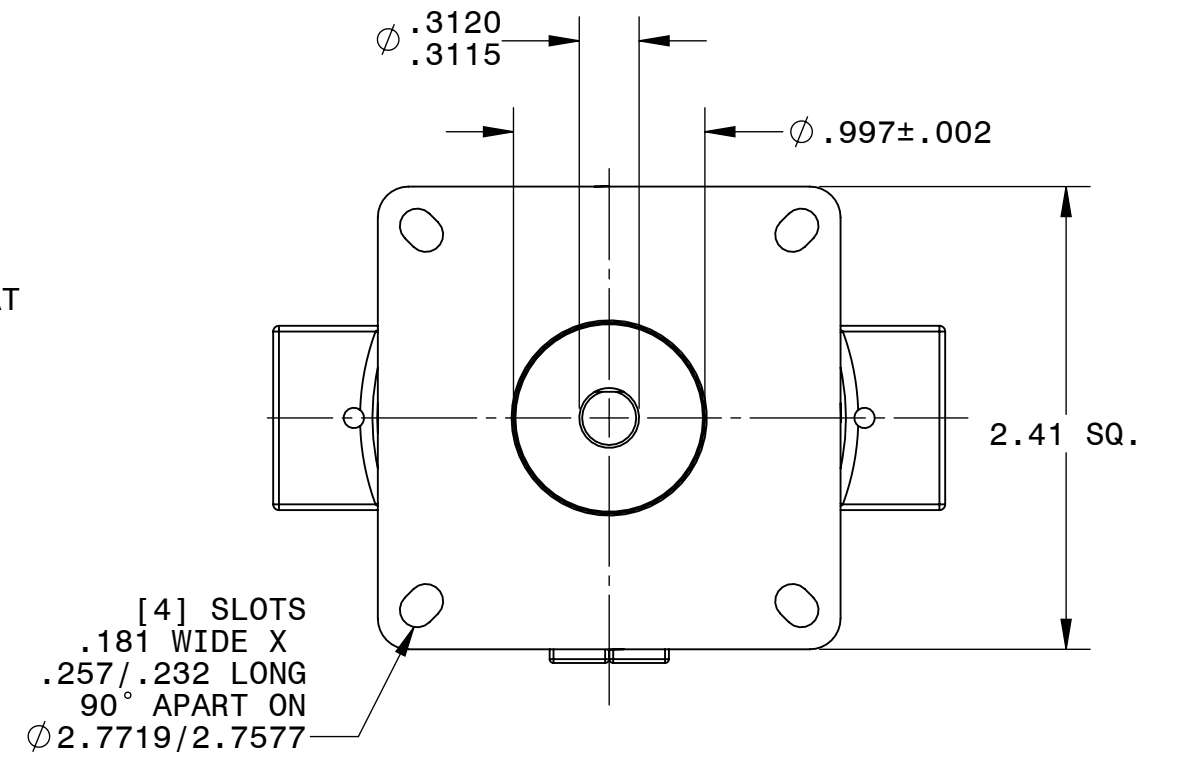

REPRESENTATIVE OF MODEL NUMBER(S):
0043 0044

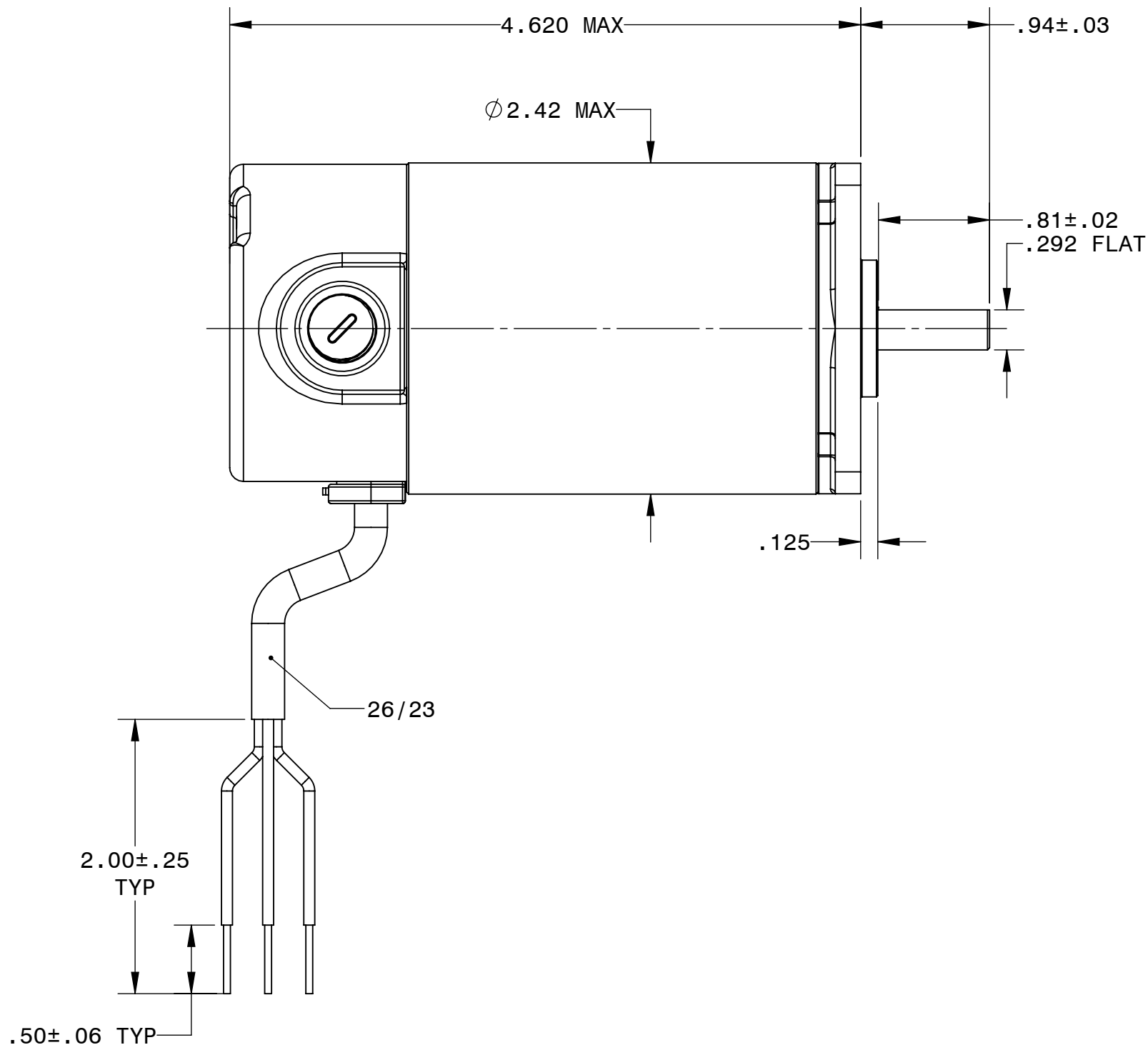
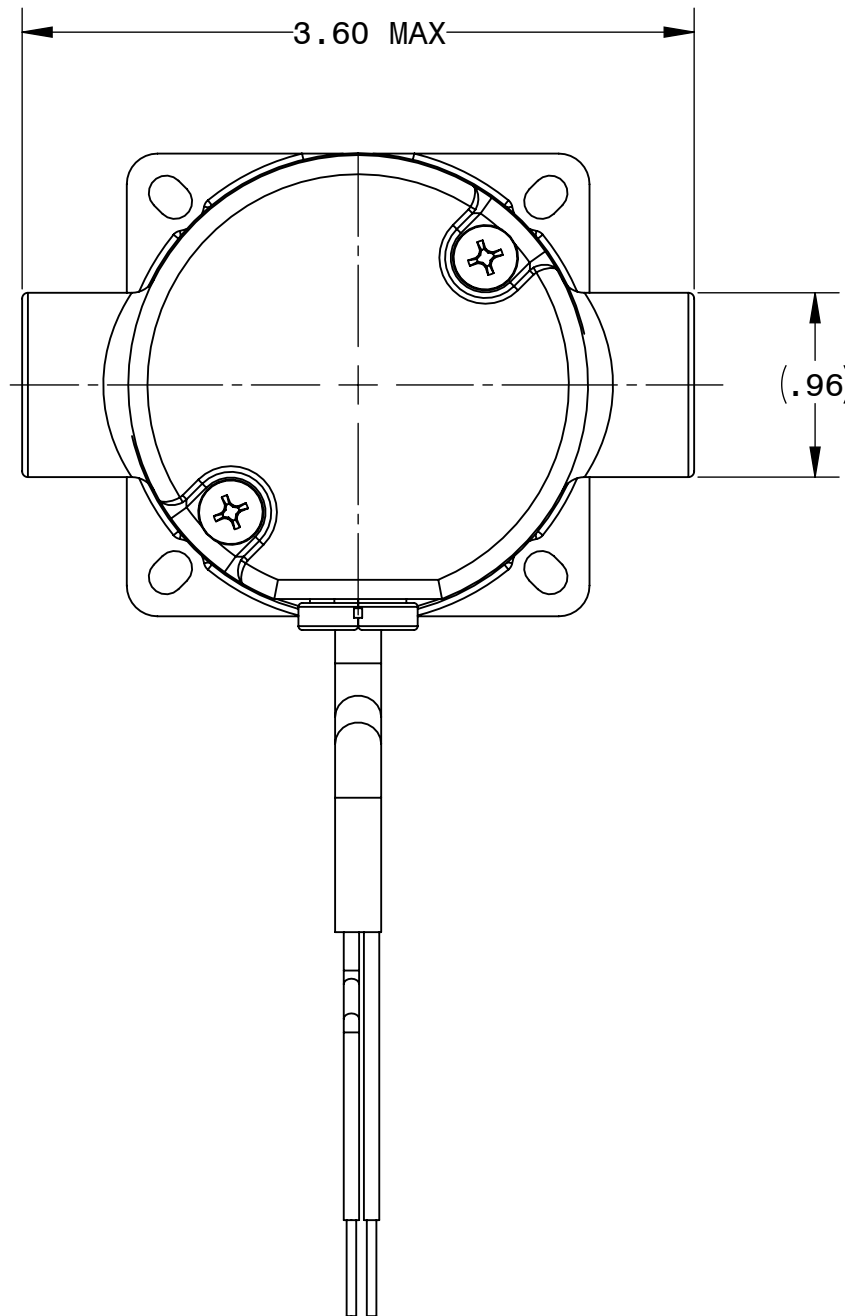