

DESCRIPTION:
MOTOR 24A4FEPM

SHEET:	1/1	UNLESS OTHERWISE SPECIFIED:
SCALE:	1:1	UNITS ARE IN INCHES [mm]
C		TOLERANCES: .XX:±.01 .XXX:±.005
		ANGLES: X°:±3° X.X°:±0.5°

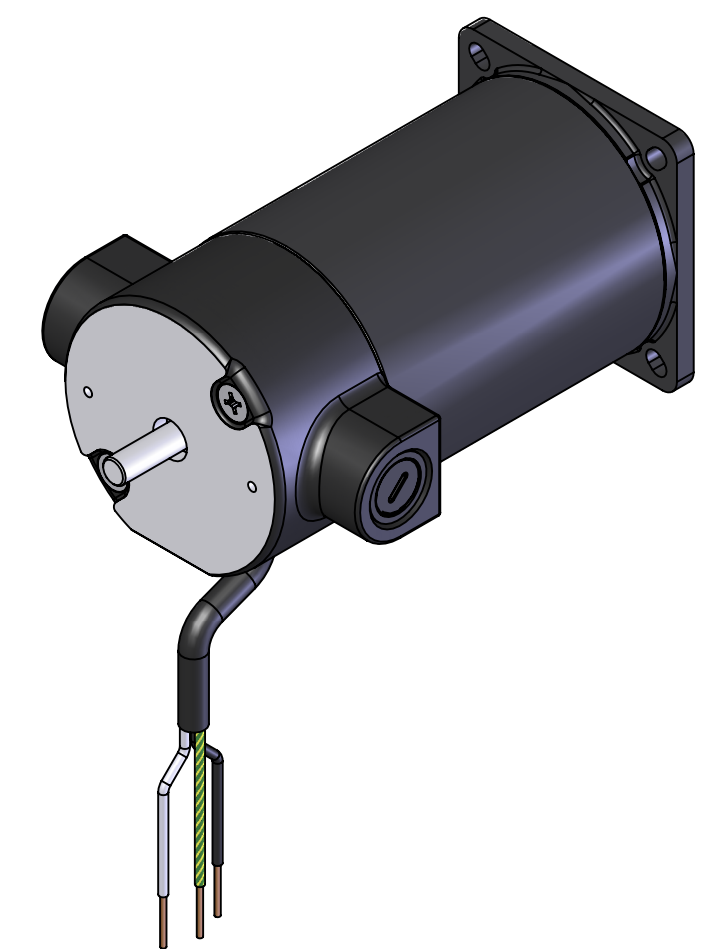
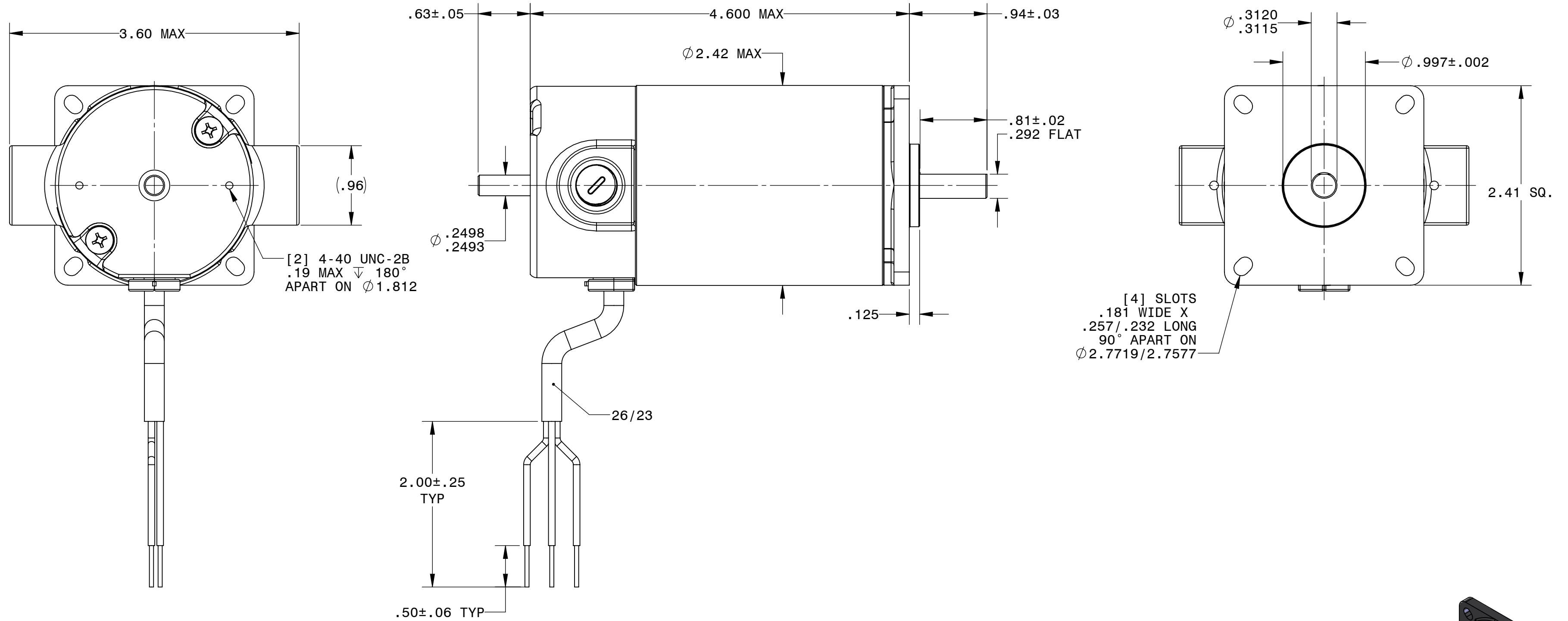

REPRESENTATIVE OF MODEL NUMBER(S) :

0047 4444