

DESCRIPTION:
GEARMOTOR 42A7FEPM-5H

SHEET: 1/1	UNLESS OTHERWISE SPECIFIED:
SCALE: 1:2	UNITS ARE IN INCHES [mm]
C	TOLERANCES: .XX:±.01 .XXX:±.005
	ANGLES: X°:±3° X.X°:±0.5°

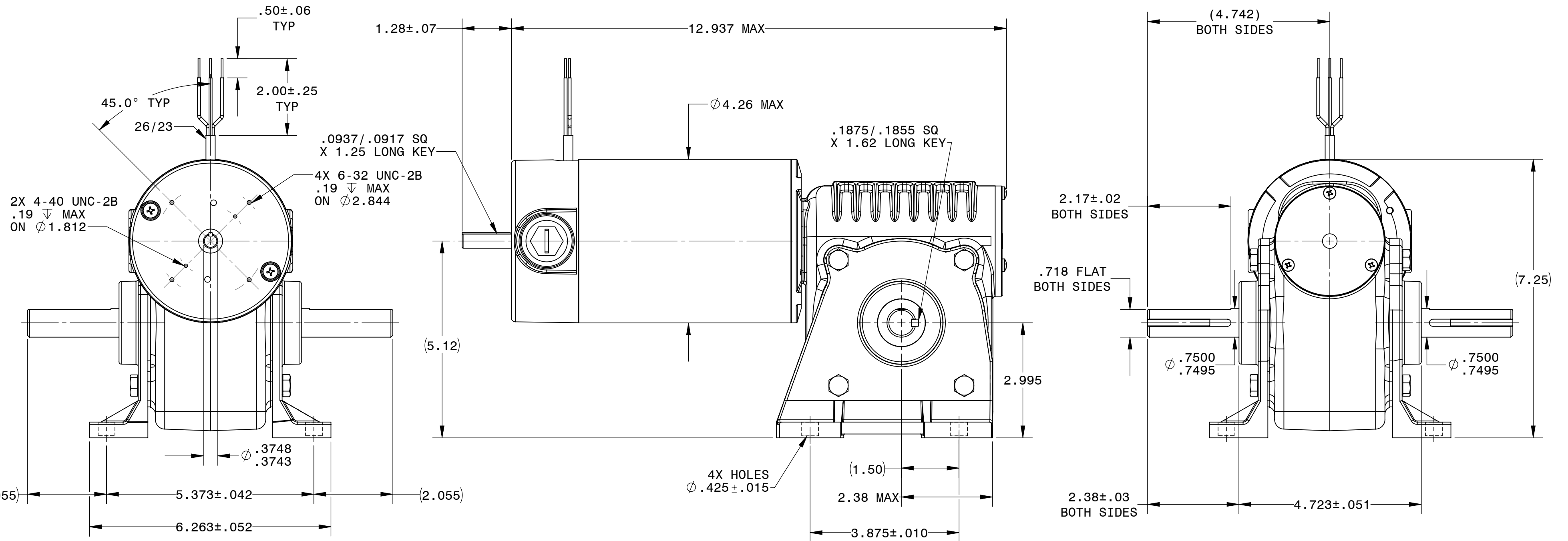

REPRESENTATIVE OF MODEL NUMBER(S):
4500 4501 4502 4503 4830 4831 4832 4833

