

DESCRIPTION:
MOTOR 33A5BEPM

SHEET: 1/1
SCALE: 1:2
C

UNLESS OTHERWISE SPECIFIED:
UNITS ARE IN INCHES [mm]
TOLERANCES: .XX:±.01 .XXX:±.005
ANGLES: X°:±3° X.X°:±0.5°

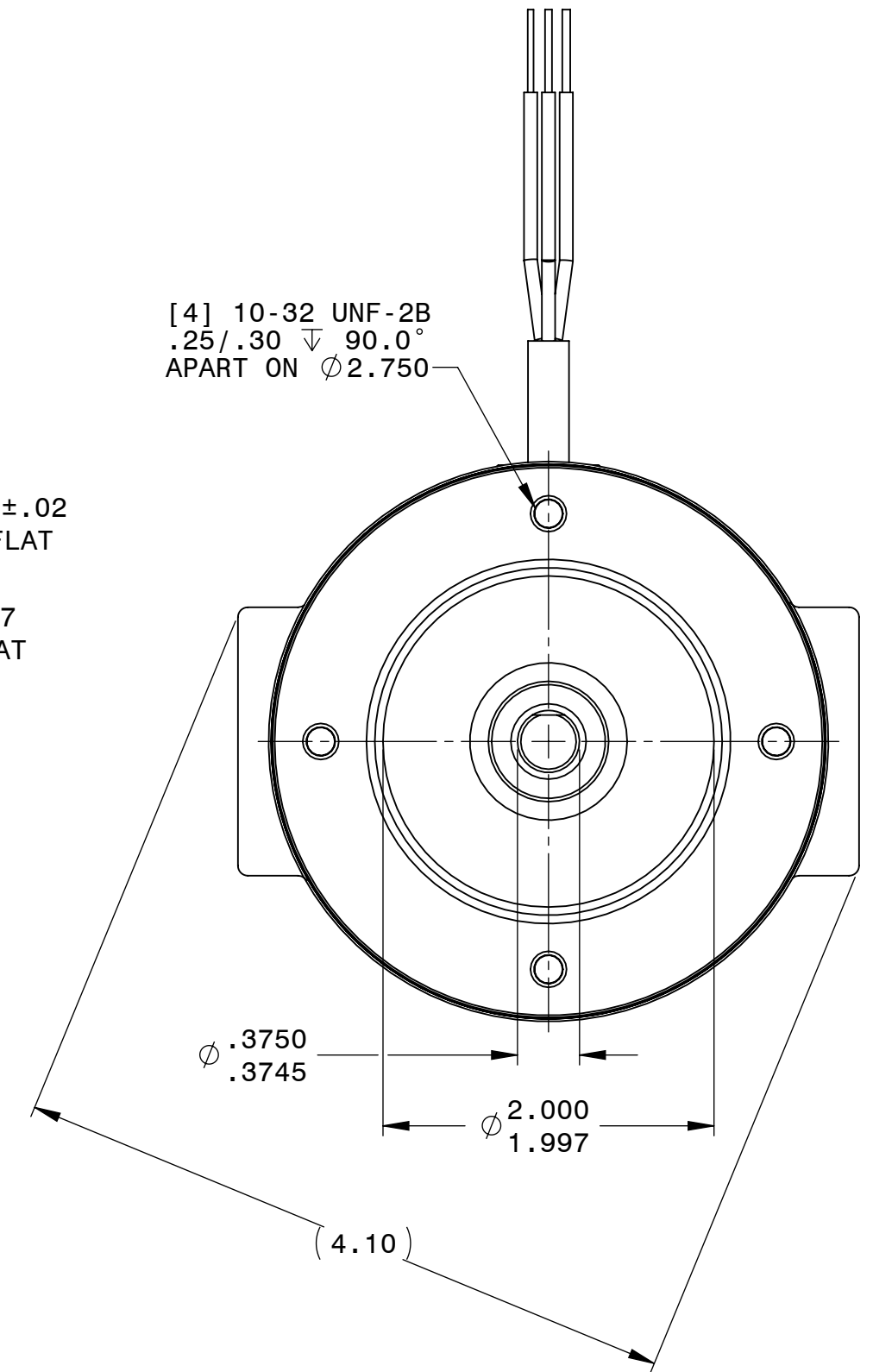
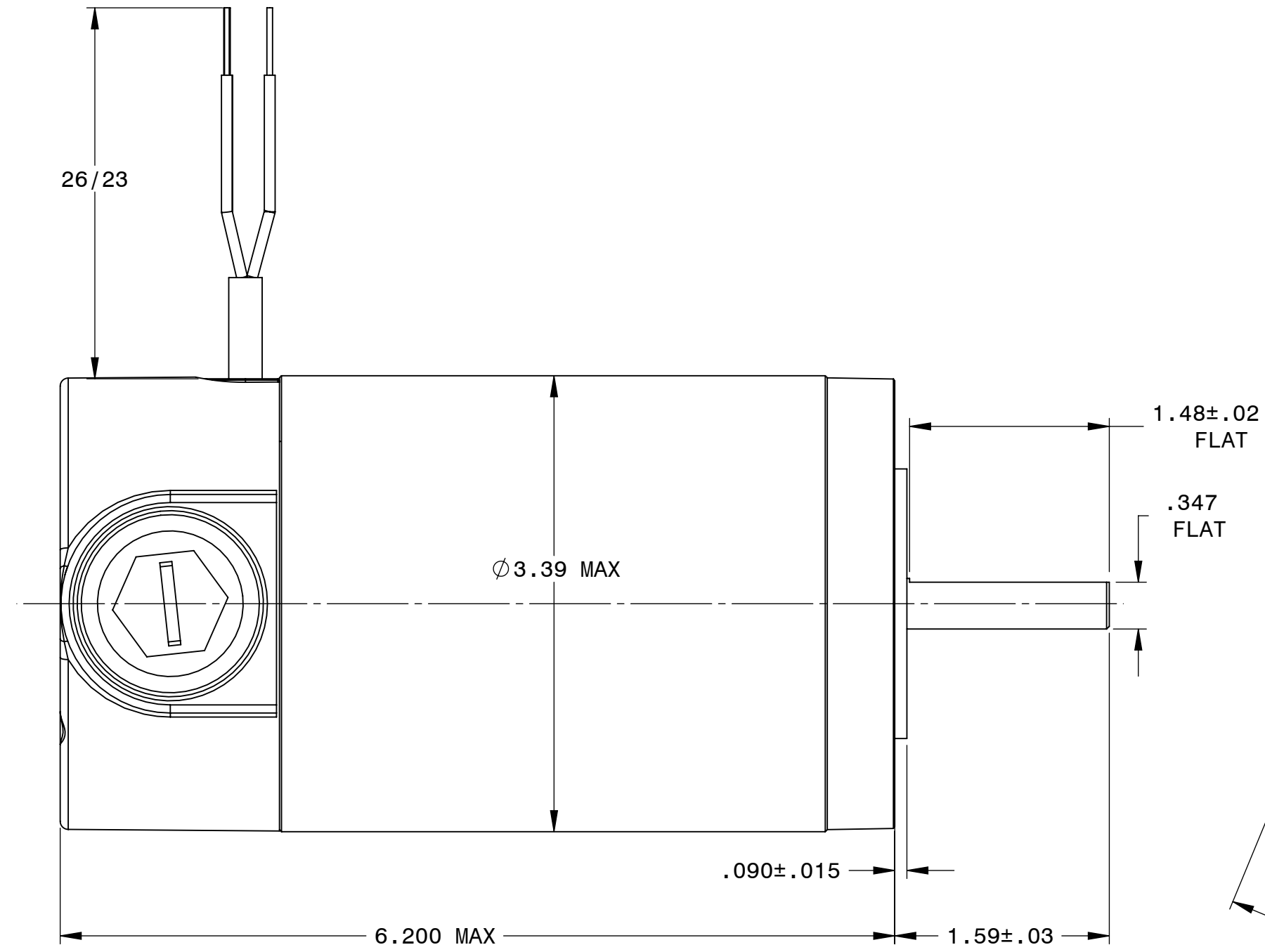
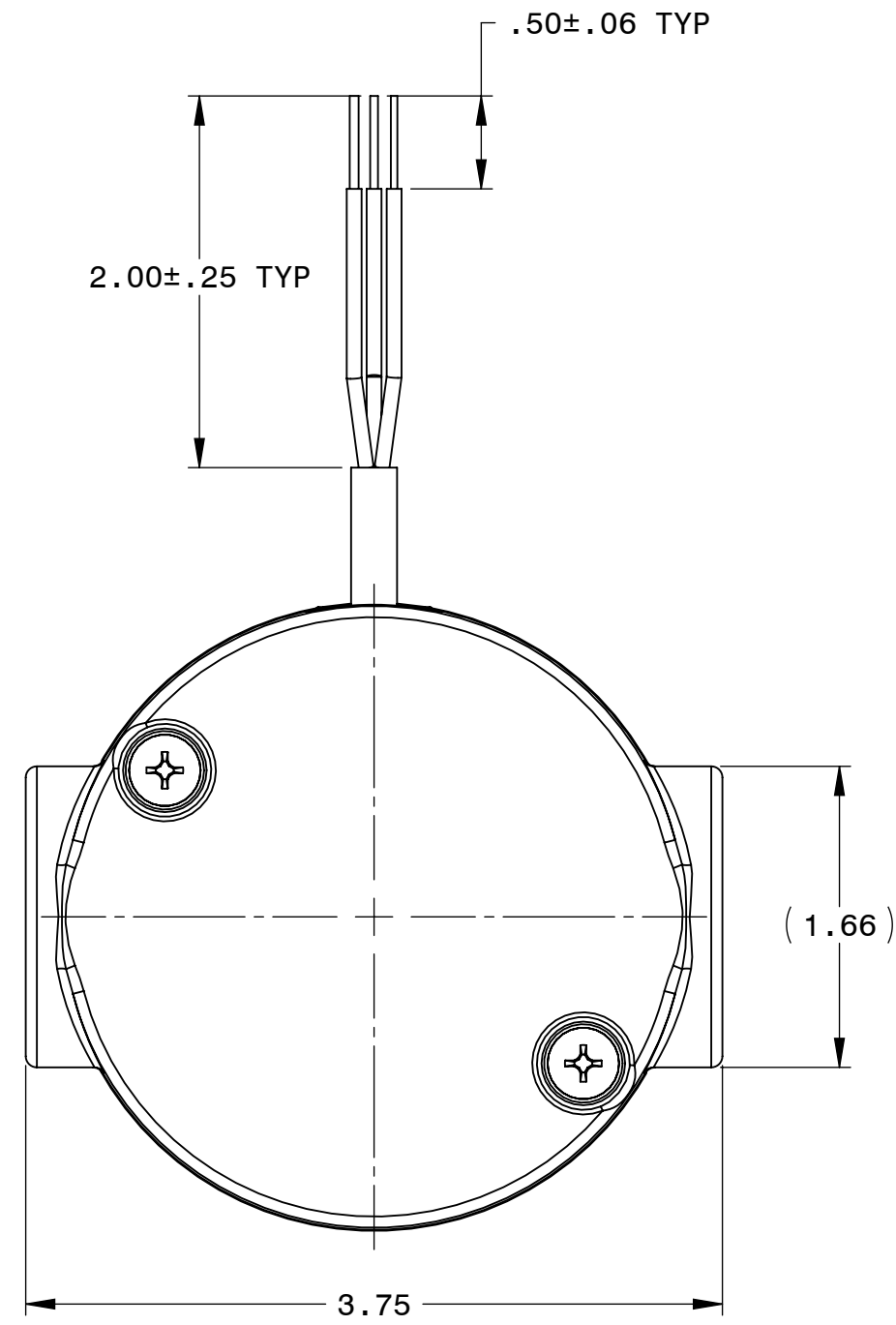

REPRESENTATIVE OF MODEL NUMBER(S):
6020

