

BODINE ELECTRIC COMPANY

PART NO./REV: INFM0265 A	
DESCRIPTION: MOTOR 34R6BF	
SHEET: 1/1	UNLESS OTHERWISE SPECIFIED:
SCALE: 1:1	UNITS ARE IN INCHES [mm]
B	TOLERANCES: .XX:±.01 .XXX:±.005 ANGLES: X°:±3° X.X°:±0.5°

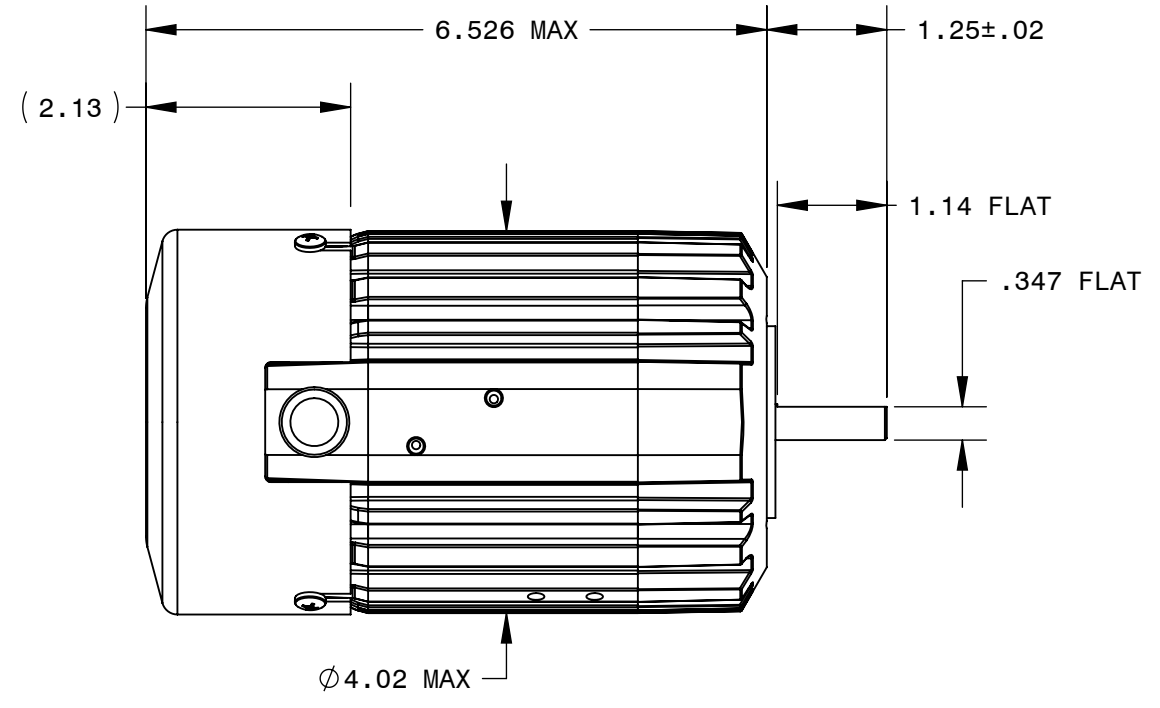

[4] 1/4-20 UNC-2B
↓.31 MIN
90°±1.0° APART
ON Ø2.75

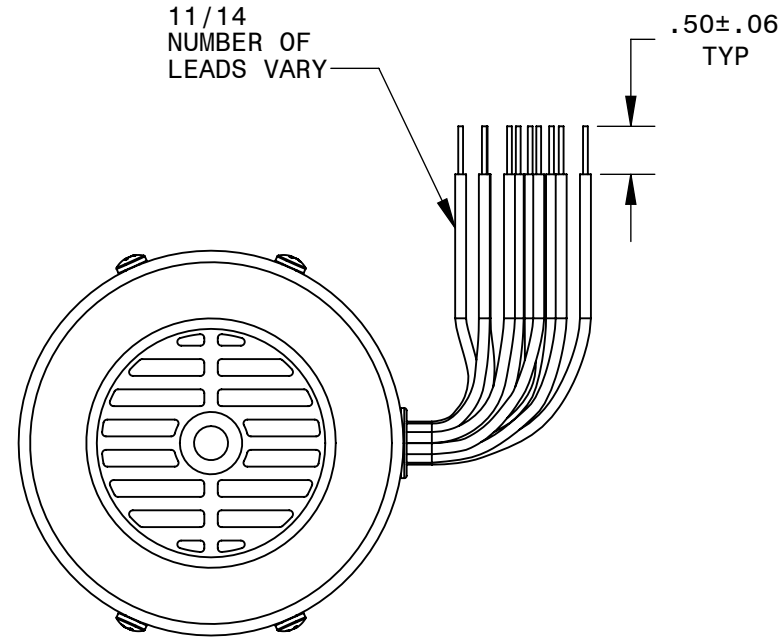
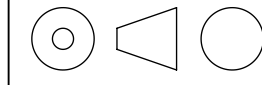
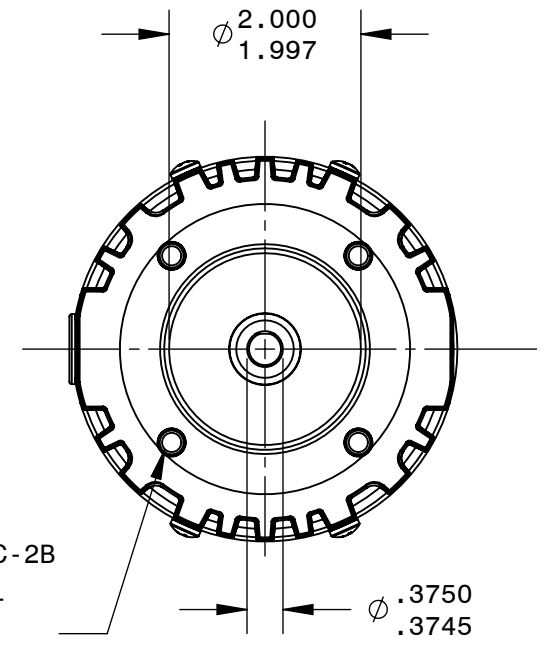

REPRESENTATIVE OF MODEL NUMBER(S):
2895

