





## Warnings and Cautions

Warning 	Dangerous Voltage Warning: warns of situations in which a high voltage can cause injury and/or equipment damage. The text next to this symbol describes ways to avoid danger.
Warning 	General Warning: warns of situations that can cause physical injury and/or equipment damage by means other than electrical. The text next to this symbol describes ways to avoid the danger.

## General Safety Instructions

Warning 	Be sure to read, understand, and follow all safety instructions.
Warning 	Only qualified electricians should carry out all electrical installation and maintenance work on reactors.
Warning 	All wiring must be in accordance with the National Electrical Code (NEC) and/or any other codes that apply to the installation site.
Warning 	Disconnect all power before working on the equipment. Do not attempt any work on a powered reactor.
Warning 	The reactor, VFD, motor, and other connected equipment must be properly grounded.
Warning 	The VFD terminals and connected cables are at a dangerously high voltage when power is applied to the VFD, regardless of motor operation.

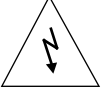
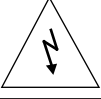
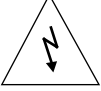
## OUTPUT

When installing the KLR/KDR Reactors on the OUTPUT side of the Variable Frequency Drive (VFD), please use the following guidelines:

- TCI recommends 1.5% impedance reactors to be used on the output of the VFD. In case of the KDR line, use only the KDR OUTPUT reactors

- Reactors should be mounted as close to the output terminals of the VFD as possible

- TCI suggests that the reactor be used in applications where the motor lead length is less than 100 feet. For applications with motor lead lengths greater than 100 feet, TCI offers V1k/KLC Output Filters and KMG MotorGuard High Performance Sinewave Filters.

- Reactors are sized by the Full Load Amps located on the motor nameplate.

Please contact TCI Technical Support or your TCI distributor for application information regarding the use of these reactors on the load or output side of the VFD or in applications where inductors are used.



# Reactor Installation Guide

---

TCI, LLC  
7878 North 86th Street  
Milwaukee, WI 53224  
Ph: 800-TCI-8282  
www.transcoil.com

---

TCI, LLC  
7878 North 86th Street  
Milwaukee, WI 53224  
Ph: 800-TCI-8282  
www.transcoil.com

Revision 3.4 Part # 24774 Mar. 29, 2011

# KLR/KDR Line Reactor Installation Instruction

## INPUT

When installing the KLR/KDR Line Reactors on the INPUT side of the Variable Frequency Drive (VFD), please use the following guidelines when wiring the unit:

■ The KLR/KDR Line Reactor is a 3-phase device and should be wired in a series and positioned on the input side of the VFD.

■ All Terminal Block connectors will be marked. A1, B1, and C1 are the input terminals where the 3 phases of incoming power are to be wired. As a result, A2, B2, and C2 are the output terminals. Units with copper bus or ring lug terminals are not marked. In these cases, either the upper terminals or lower terminals can be used as the input terminals as long as the selection is consistent. For example, if an upper terminal is selected as the input, all upper terminals must be input terminals. Wiring from the output terminals should connect to the input of the VFD.

■ Refer to NEC wiring practices for appropriate wire sizes for your application.

■ Power Wiring: Only use 75°C copper conductors unless the wire connector is marked for Al/Cu, then the use of aluminum wire is permitted.

■ TCI recommends that these reactors be wired and located as close to the front end of the VFD as possible to have the greatest success in both protecting the VFD as well as mitigating line harmonics.

■ In standard 40°C ambient or less installations, a clearance of 3 inches on all sides of the reactors and its enclosure is recommended for assisting in heat dissipation and ample wire bending space. This is a general guideline for typical applications. If the reactor is being installed next to a heat sensitive instrument or control device, we recommend reviewing specific requirements or heat limitations. Line reactor heat loss information is available on the web at [www.transcoil.com](http://www.transcoil.com).

■ These reactors are designed to be floor-mounted or wall-mounted. Large open-style devices should be panel mounted by incorporating a bracket that would act as a shelf to support the reactor and/or enclosure. When installing an open style device in an existing control cabinet, drive cabinet, motor control center, or other large enclosure, the reactor should be mounted in the lower half of the cabinet to prevent hot spots or pockets of heat (this typically allows better thermal dissipation and heat convection). Reactors with ducts must be mounted in such a way that maximizes air flow. Reactors with ducts are designed to be mounted vertically for proper cooling.

## Field Wiring Information

Below is the typical wiring diagram for the 3-phase reactor applied to the front end of the Variable Frequency Drive (VFD).

Single-phase applications are acceptable, however, it is important to size the unit based on the single phase Full Load Amperage of the VFD. The input and output connections should be on terminals A and C to ensure proper performance.

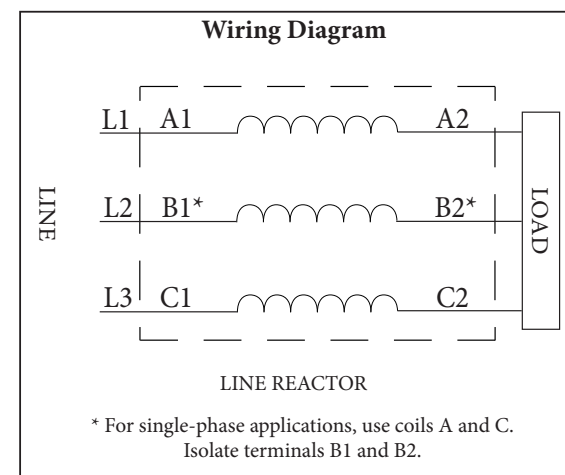

## Product Specifications

- ▶ 3-Phase, 600 Volt Class
- ▶ UL Recognized; File E-116124
- ▶ CE Marked
- ▶ CSA Certified
- ▶ Current-rated device
- ▶ 200% rated current for 3 minutes
- ▶ Ambient Temperature: 40°C