

DESCRIPTION:
MOTOR 42A7BEPM METRIC

SHEET: Sheet 1
SCALE: 2:3
C

UNLESS OTHERWISE SPECIFIED:
UNITS ARE IN mm [INCHES]
ANGLES: X°:±3° X.X°:±0.5°

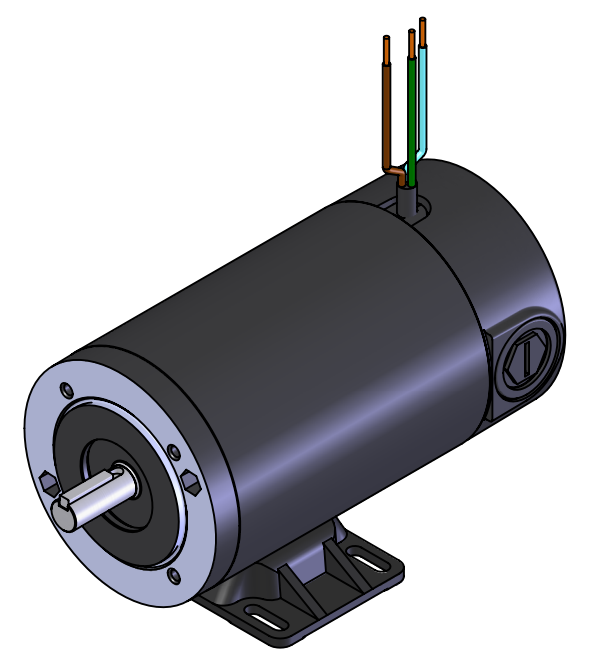
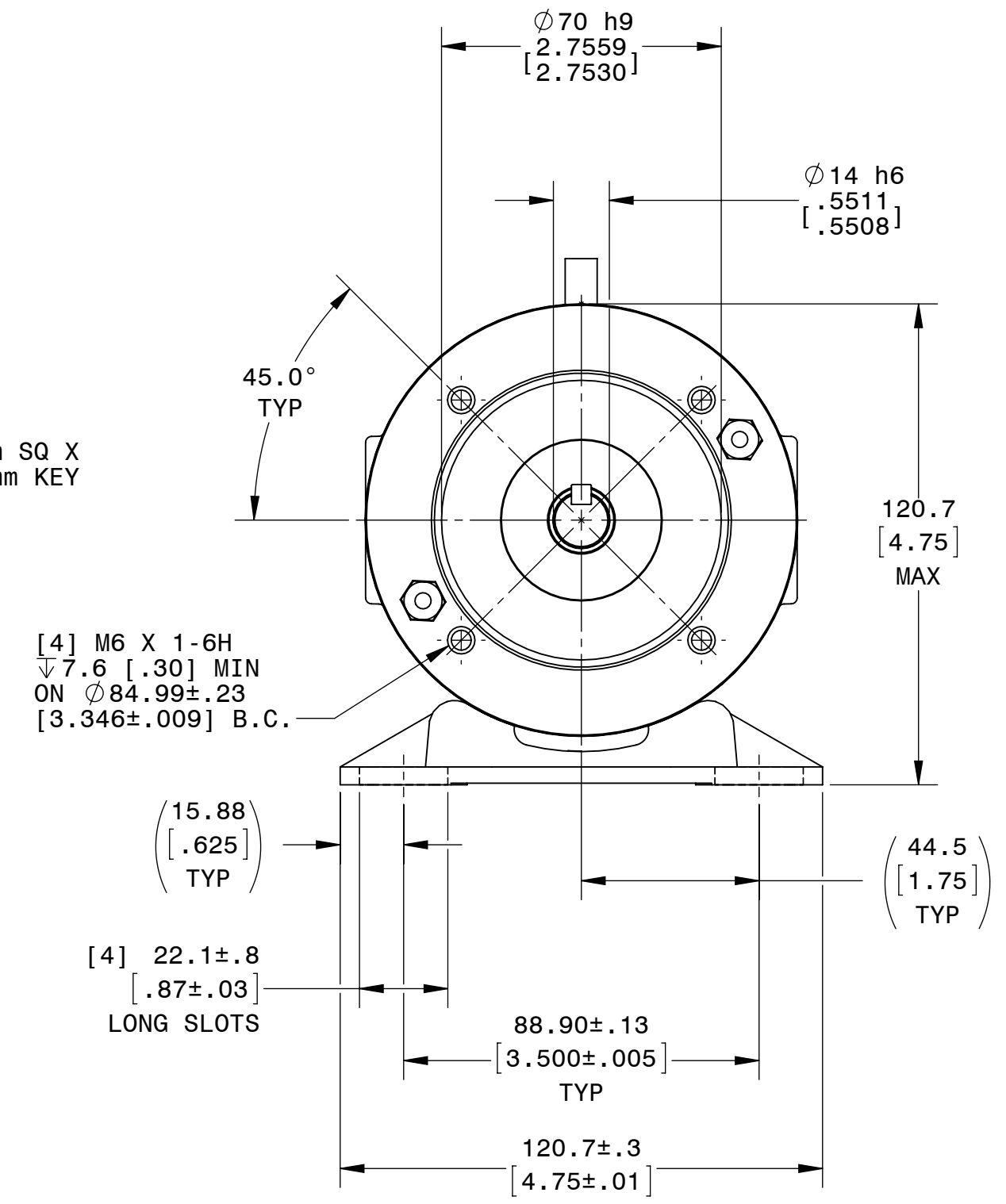
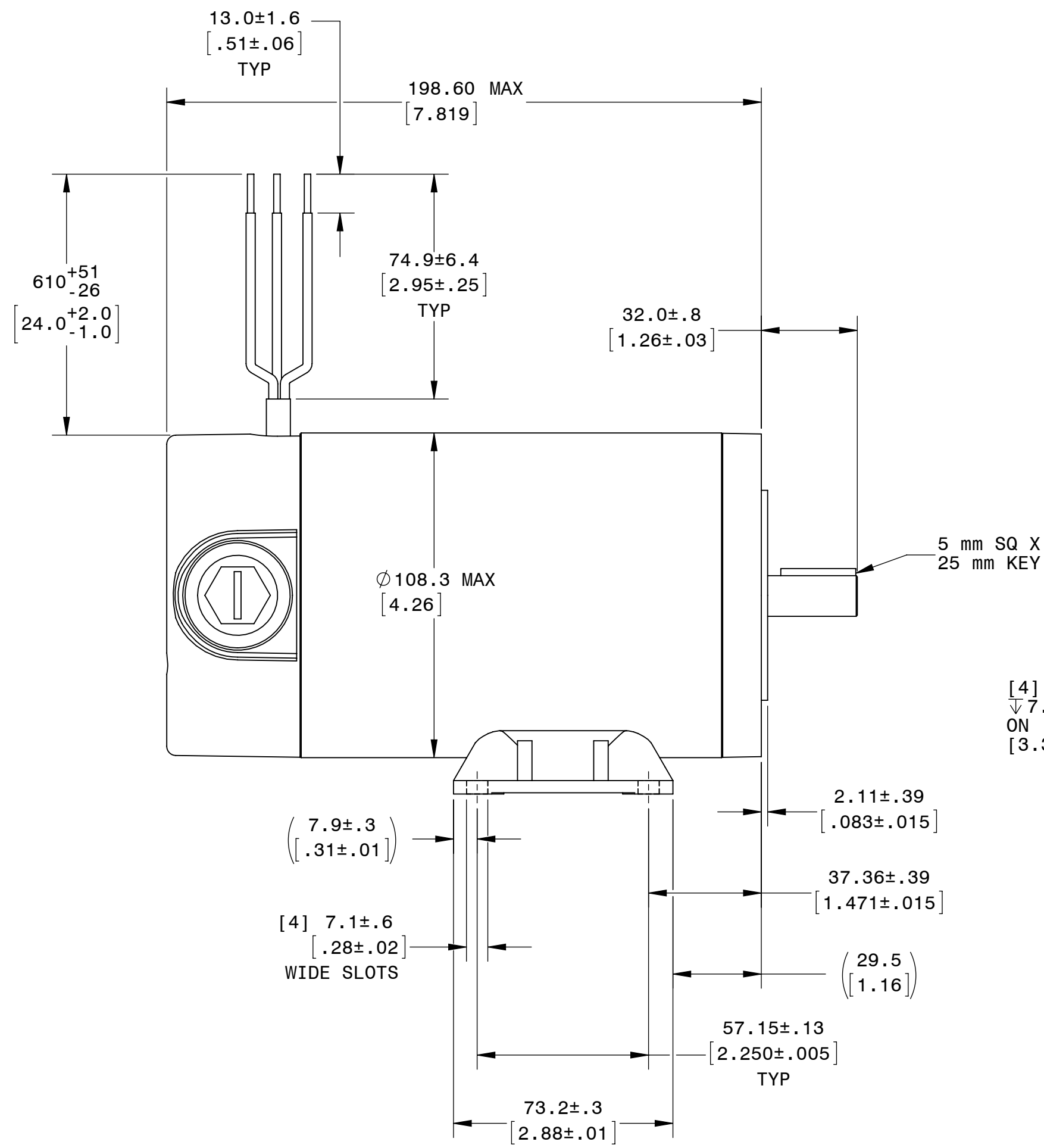
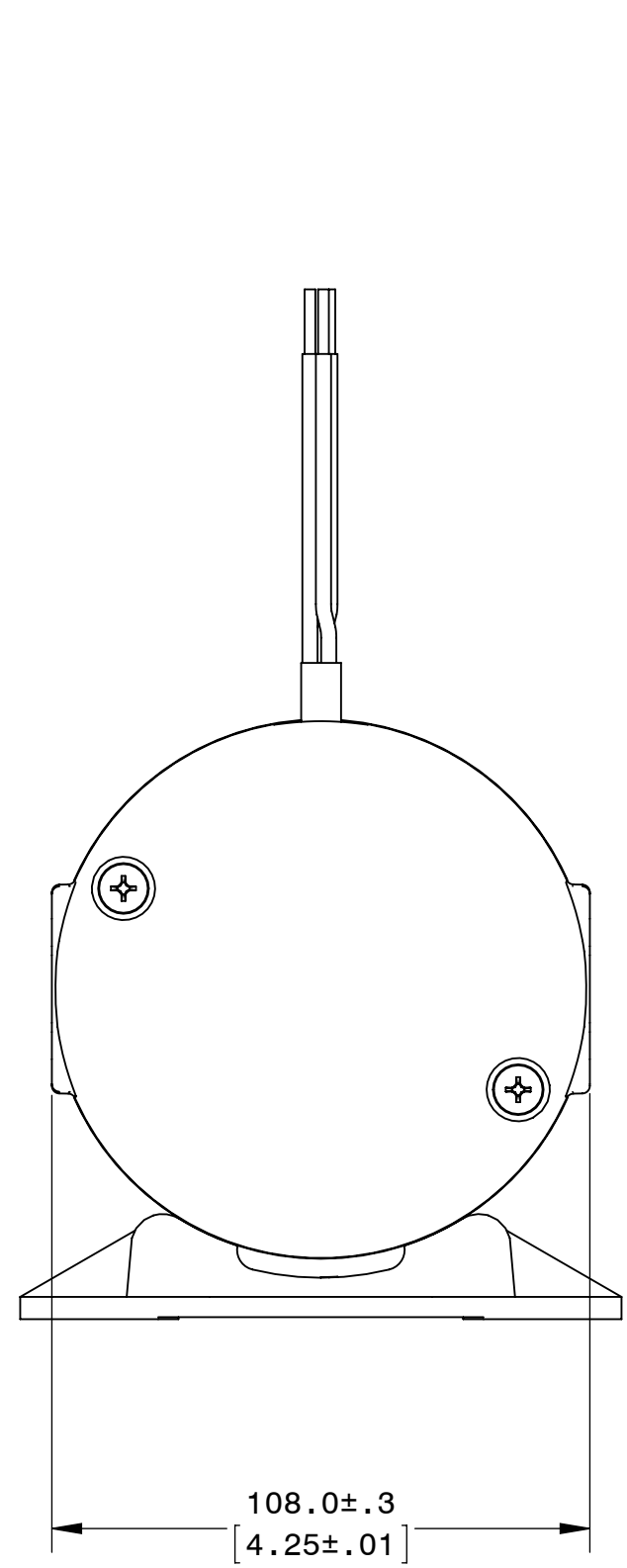

REPRESENTATIVE OF MODEL NUMBER(S):
4231 4237