



Signal Isolator SIMG (Part No. 8832) Installation and Wiring Instructions for Model KBMG with 2-Piece Finger-Safe Cover

This document is supplied with Model KBMG only.



Warning! Before installing the SIMG onto the KBMG, the AC power must be disconnected.

The following Installation and Wiring instructions are to be used as a supplement to the KBMG Installation and Operating Instructions Manual (Part No. A40263). Refer to the SIMG Installation and Operating Instructions Manual (Part No. A40269) for specific and external signal following connections. See Figures 1 - 5, on page 2.

Tools required for installation: small flat blade screwdriver, long nose pliers, cutters.

Notes: 1. To install the SIMG, be sure the Top Panel of the KBMG 2-Piece Finger-Safe Cover (FSC) is not installed. 2. All trimpots and jumpers, on the KBMG, must be set before installing the SIMG.

1 Preparing the KBMG Prior to Installing the SIMG - See Figure 1.

- 1.1 Insert the flat blade screwdriver between the KBMG PC Board and Terminal Block TB1 and gently pry it off. Discard the Terminal Block.

Note: When prying off the Terminal Block, care should be taken to not scratch circuit traces that are on the PC Board surface.

- 1.2 Using a flat blade (or Phillips) screwdriver, remove the screw from the KBMG FSC. Retain this screw for use in Section 3.3, below.
- 1.3 Using long nose pliers, remove and discard the Terminal Boots that are factory installed on Terminals "F-" and "F+" on the KBMG.

2 Preparing the SIMG for Installation onto the KBMG - See Figure 2.

Note: If the SIMG does not contain a Ring Lug and Cable Tie, proceed to paragraph 3 below.

- 2.1 Using long nose pliers, carefully uncurl the Ring Lug off the Cable Assembly.
- 2.2 Using cutters, carefully remove the Cable Tie from the SIMG.
- 2.3 Discard the Ring Lug and Cable Tie.

3 Installing the SIMG onto the KBMG - See Figure 3.

- 3.1 Align and gently push the Terminal Block on the SIMG onto the Terminal Block Header on the KBMG.
- 3.2 Align the (3) Holes on the SIMG with the (3) Snap Posts on the KBMG FSC. Gently press the SIMG Board onto the (3) Snap Posts. Apply pressure at each Snap Post.
- 3.3 Install the Screw, that was removed in Section 1.2, and gently tighten it to secure the SIMG onto the KBMG FSC. Do not overtighten.

4 Wiring the SIMG After Installed onto the KBMG - See Figures 4 and 5.

Note: On older SIMG models, the Brown and Yellow Wires must be crisscrossed, as shown in Figure 3. On newer SIMG models, the Brown and Yellow Wires are not crisscrossed.

- 4.1 Carefully insert the Cable Assembly through the Retainer Clip on the KBMG FSC.
- 4.2 Connect the Brown Wire (larger terminal) to Terminal F- on the KBMG.
- 4.3 Connect the Yellow Wire (smaller terminal) to Terminal F+ on the KBMG.

5 Installing the SIMG Finger-Safe Cover - See Figure 3.

Align the (4) Snap Tabs on the SIMG FSC with the (4) slots on the KBMG FSC. The Cable Shroud must be positioned over the Cable Assembly (Brown and Yellow Wires). Apply pressure to snap the cover into position.

Note: Be sure that the Cable Assembly is centered in the Retaining Clip so the wires are not damaged by the Cable Shroud.

The SIMG Installation is now complete.



Signal Isolator SIMG (Part No. 8832) Installation and Wiring Instructions for Model KBMG with 2-Piece Finger-Safe Cover

Figure 1 - Preparing the KBMG Prior to Installing the SIMG

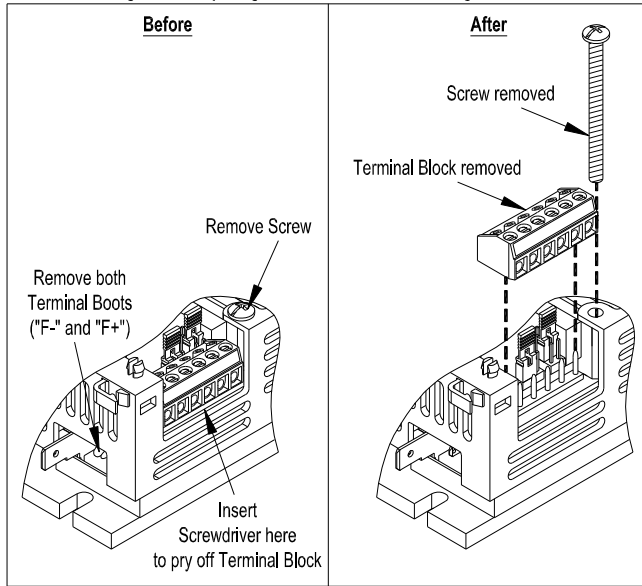

Figure 2 - Preparing the SIMG for Installation onto the KBMG

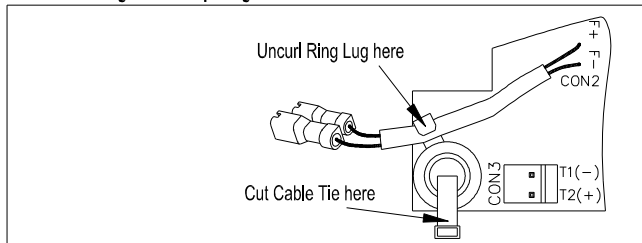

Figure 4 - Wiring the SIMG After Installed onto the KBMG

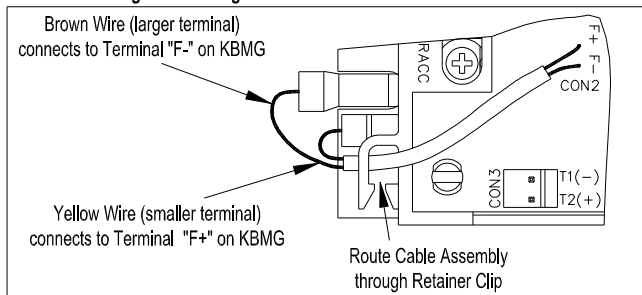

Figure 5 - View of KBMG Terminals "F-" and "F+"

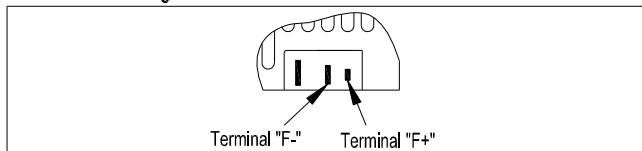
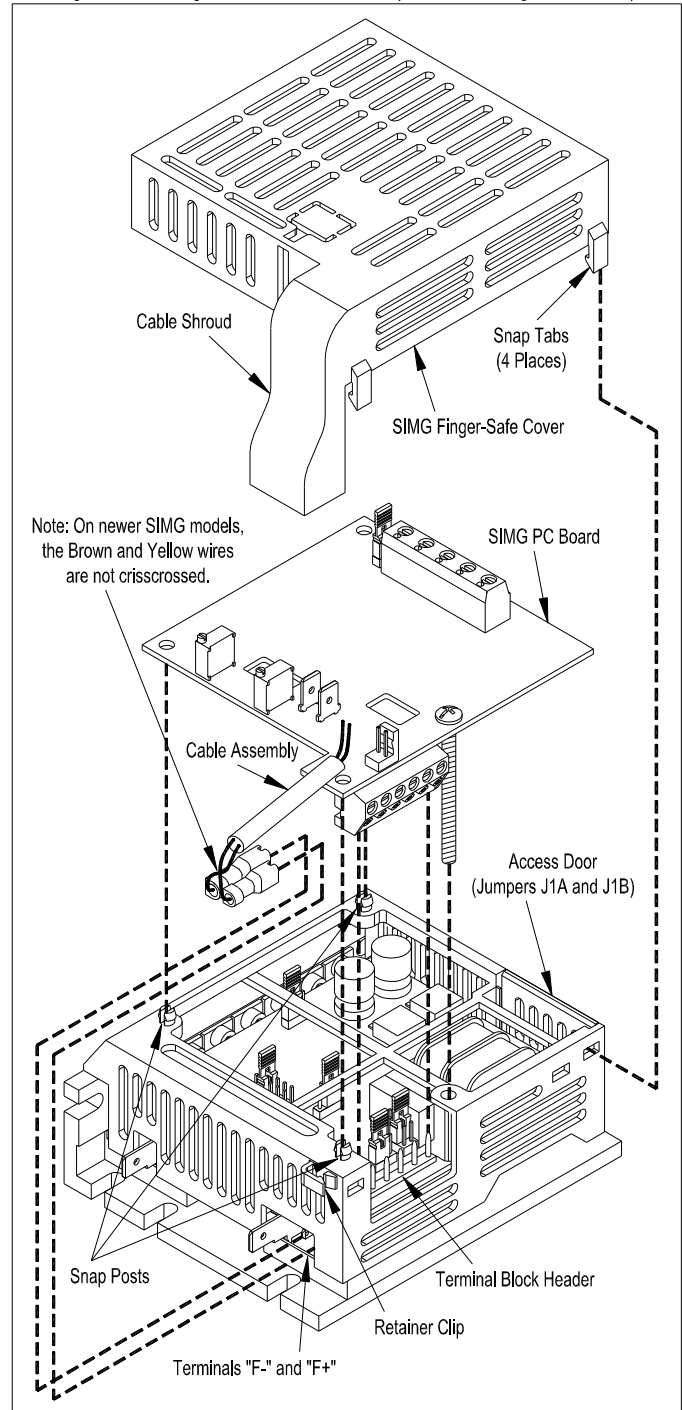

Figure 3 - Installing the SIMG onto the KBMG (with 2-Piece Finger-Safe Cover)





i. KBMG-212D SIMPLIFIED OPERATING INSTRUCTIONS

IMPORTANT – You must read these simplified operating instructions before you proceed. These instructions are to be used as a reference only and are not intended to replace the detailed instructions provided herein. You must read the Safety Warning before proceeding.

1. CONNECTIONS.

A. AC Line – Wire AC line voltage to terminals L1 and L2. Be sure jumpers J1A and J1B are both set to the correct input line voltage 115 or 230 VAC. Connect ground wire (earth) to green ground screw.

B. Motor.

1. Permanent Magnet (PM Type). Connect motor armature leads to M1(+) and M2 (-). Be sure jumper J3 is set to the proper position "A90" for 90 volt DC motors and "A180" for 180 volt DC motors. Note: 180 volt DC motors must be used with 230 VAC line, 90 volt motors can be used with a 230 VAC or 115 VAC line.

Note: Motor performance and efficiency, including brush life, can be adversely affected when using 90 volt motors with a 230 VAC line. Contact motor manufacturer for derating information.

2. Shunt Wound Motors. Connect motor armature leads as above. Connect full voltage shunt field leads (90 volt motors with 100 volt fields and 180 volt with 200 volt fields) to F+ and F-. Connect half voltage field leads (90 volt motors with 50 volt fields and 180 volt motors with 100 volt fields) to F+ and L1.

1

2. MOTOR CURRENT.

Jumper J2 is factory set for 7.5 amp motors (7.5A). For lower amperage motors, place J2 in the proper position. If motor amperage is less than 1.7 amps, use the 1.7 amp position and readjust the IR and CL trimpots according to section VII, C and D on pages 28 and 29. Note: The factory setting for Current Limit is 150% of the nominal current setting (e.g., if J2 is selected for 5 amps, the actual CL setting will be 7.5 amps). **Note:** If the 10.0 amp setting (10.0A) is required, an auxiliary heatsink (KB P/N 9861) must be used.

3. TRIMPOT SETTINGS.

All trimpots have been factory set in accordance with figure 12, p. 20.

4. ENABLE.

A jumper must be connected between "EN" and "COM" terminals or control will not operate. (See sec. V, G, page 22.)

Note: For the location of jumpers and trimpots, see fig. 12, control layout, on page 20.

5. SPEED OR TORQUE MODE.

Jumper J5 is factory set for speed control operation (SPD). For torque control, set J5 to the "TRQ" position.



ii. SAFETY WARNING! — PLEASE READ CAREFULLY

This product should be installed and serviced by a qualified technician, electrician or electrical maintenance person familiar with its operation and the hazards involved. Proper installation, which includes wiring, mounting in proper enclosure, fusing or other overcurrent protection and grounding, can reduce the chance of electric shocks, fires or explosion in this product or products used with this product, such as electric motors, switches, coils, solenoids or relays. Eye protection must be worn and insulated adjustment tools must be used when working with control under power. This product is constructed of materials (plastics, metals, carbon, silicon, etc.) which may be a potential hazard. Proper shielding, grounding and filtering of this product can reduce the emission of radio frequency interference (RFI) which may adversely affect sensitive electronic equipment. If information is required on this product, contact our factory. It is the responsibility of the equipment manufacturer and individual installer to supply this safety warning to the ultimate user of this product. (SW effective 11/92)

This control contains electronic Start/Stop and enable circuits that can be used to start and stop the control. However, these circuits are never to be used as safety disconnects since they are not fail-safe. Use only the AC line for this purpose.

The input circuits of this control (potentiometer, start/stop, enable) are not isolated from AC line. **Be sure to follow all instructions carefully. Fire and/or electrocution can result due to improper use of this product.**

3

CE This product complies with all CE directives pertinent at the time of manufacture. Contact factory for detailed installation instructions and Declaration of Conformity. Installation of a CE approved RFI filter (KBRF-200A, KB P/N 9945C or equivalent) is required. Additional shielded motor cable and/or AC line cables may be required along with a signal isolator (model SIMG, KB P/N 8832 or equivalent).

I. GENERAL INFORMATION.

The KBMG-212D is a full-wave regenerative control, capable of operating a DC motor (Permanent Magnet or Shunt) in a bidirectional mode. It provides 4-quadrant operation which allows forward and reverse torque in both speed directions. The drive offers excellent controllability, which closely approximates the performance of servo-type drives. Ratings and specifications are presented in tables 1 and 3. Be sure the drive is used within these ratings and specifications.

(Note: Regenerative drives normally produce more motor heating than standard unidirectional SCR speed controls, especially under low speed operation. This should be taken into consideration when specifying motor rating.)



WARNING! Be sure to follow all instructions carefully. Fire or electrocution can result due to improper use of this product. Read Safety Warning.

4

TABLE 1 – ELECTRICAL RATINGS

Model No.	KB Part No.	AC Line Voltage (VAC) ± 10% 50/60 Hz	Motor Voltage (VDC)	Rating Without Auxiliary Heatsink		
				Max. AC Load Current (RMS Amps)	Max. DC Load Current (Avg. Amps)	Maximum Horsepower HP, (KW)
KBMG-212D	8831	115	0 – ± 90	12.0	8.0	0.75, (0.5)
		230	0 – ± 180	12.0	8.0	1.5, (1.0)

Model No.	KB Part No.	AC Line Voltage (VAC) ± 10% 50/60 Hz	Motor Voltage (VDC)	Rating With Auxiliary Heatsink (KB P/N 9861)		
				Max. AC Load Current (RMS Amps)	Max. DC Load Current (Avg. Amps)	Maximum Horsepower HP, (KW)
KBMG-212D	8831	115	0 – ± 90	16.0	11.0	1, (0.75)
		230	0 – ± 180	16.0	11.0	2, (1.5)

II. OPERATION.

The KBMG-212D will vary motor speed or torque as a function of the signal voltage on input terminals "SIG" (signal) and "COM" (common). The input voltage can be derived from the wiper of the main speed potentiometer or from an *isolated* analog input (signal voltage following mode). Since the KBMG-212D is a 4-quadrant regenerative drive, the motor speed will follow both a positive and negative signal voltage and drive the motor in both the forward direction and reverse direction. In addition, it will apply both forward and reverse torque in order to stabilize motor speed.

5

To understand the concept of a regenerative drive, the operation of an elevator can be used. If one were to enter the elevator on the first floor and press 10, the motor and control would have to lift the elevator against gravity. In this mode, the drive would operate like a conventional speed control which is called "motoring" (the applied load is opposite to the direction of motor rotation). When the elevator is at floor 10 and floor 1 is pressed, gravity will try to pull the elevator car down faster than the speed for which it is set. The control will then provide reverse torque to keep the car from falling faster than the set speed. This operation is regeneration (the applied load is in the same direction as the direction of motor rotation).

The table below summarizes the different modes of operation.

TABLE 2 – SUMMARY OF CONTROL OPERATION

Quadrant	Type of Operation	Motor Rotation Direction	Motor Torque Direction	Applied Load Direction
I	Motoring	CW	CW	CCW
II	Regeneration	CCW	CW	CCW
III	Motoring	CCW	CCW	CW
IV	Regeneration	CW	CCW	CW

TABLE 3 – GENERAL PERFORMANCE SPECIFICATIONS

Parameter	Specification	Factory Setting
AC Line Input Voltage (VAC $\pm 10\%$ 50/60 Hz)	115 or 230	230
AC Line Frequency (Hz)	50/60	—
Armature Voltage Range 115VAC Line (VDC)	0 – ± 90	—
Armature Voltage Range 230VAC Line (VDC)	0 – ± 90 , 0 – ± 180	0 – ± 180
Field Voltage at 115VAC Line (VDC)	100/50	—
Field Voltage at 230VAC Line (VDC)	200/100	—
Max Load Capacity (% for 2 Minutes)	150	—
Ambient Temperature Operating Range ($^{\circ}\text{C}$)	0 – 50	—
Speed Range (Ratio)	50:1	—
Armature Feedback Load Regulation (% Base Speed)	± 1	—
Tach-generator Feedback Load Regulation (% Set Speed)	± 1	—
AC Line Regulation (% Base Speed)	± 0.5	—
Current Ranges (Amps DC)	1.7, 2.5, 5.0, 7.5, 10*	7.5
Forward Accel (FACC) and Reverse Accel (RACC) Range (Sec.)	0.1 – 15	1
Dead Band Range (% Base Speed)	0 – ± 5	1
Max Speed Trimpot Range (% Base Speed)	55 – 110	100
IR Comp Range at 115VAC Line (VDC @ Full Load)	0 – 20	5
IR Comp Range at 230VAC Line (VDC @ Full Load)	0 – 40	10

Continued next page

7

TABLE 3 – GENERAL PERFORMANCE SPECIFICATIONS (Continued)

Parameter	Specification	Factory Setting
Forward CL (FCL) and Reverse CL (RCL) Range (% Range Setting)	0 – 175	150
Voltage Following Input Range (VDC)**	0 – ± 10 , 0 – ± 15	0 – ± 15
Voltage Following Linearity (% Base Speed)	± 0.5	—

* Requires Auxiliary Heatsink KB P/N 9861.

** Requires isolated input or signal isolator.





III. SETTING SELECTABLE JUMPERS.

The KBMG-212D has customer selectable jumpers which must be set before the control can be used (refer to fig. 1, p. 10). **Bold** indicates factory setting. See fig. 12, p. 20 for location of jumpers.

A. J1A, J1B – Input AC Line Voltage – Select proper input line voltage, 115VAC or 230VAC, by placing both J1A and J1B in the correct corresponding position, “115” or “**230.**” (See fig. 1, p. 10.)

B. J2 – Armature Current – Select the J2 position (1.7, 2.5, 5.0, **7.5**, 10) closest to the rated motor current. (Note: The maximum output current is set to 150% of the J2 position, which may be readjusted using the FWD CL and REV CL trimpots.)

TABLE 4 – JUMPER J2 POSITION vs MOTOR HORSEPOWER

	Jumper J2 Position Motor Current (DC Amps)	Motor Horsepower HP, (KW)	
		90VDC	180VDC
10.0A 	10.0A*	1.0, (0.75)	2.0, (1.5)
7.5A 	7.5A	3/4, (0.5)	1, (1.0)
5.0A 	5.0A	1/2, (0.37)	1.0, (0.75)
2.5A 	2.5A	1/4, (0.18)	1/2, (0.37)
1.7A 	1.7A	1/6, (0.12)	1/3, (0.25)

* 10.0A setting requires auxiliary heatsink KB P/N 9861

C. J3 – Motor Armature Voltage – Select the desired armature voltage by placing J4 in the proper position, “A90” or “A180.” **Note: For 115 volt AC line input, J3 must be set to “A90.”** For 230 input, the armature voltage is normally set for “A180.” However, it is also possible to set the armature voltage to “A90” for step-down operation. (See fig. 2 and table 5 on page 10.)

J3 – Tach-Generator Feedback (for use with 1800 RPM motors.) – Jumper J3 is also used if tach-generator feedback is to be used. (See fig. 2, p. 10) If a 7 volt per 1000 RPM tach-generator is used, set jumper J4 in the “T7” position. For a 50 volt per 1000 RPM tach-generator, set the jumper in the “T50” position. **Note:** When using tach-generator feedback, the IR Comp trimpot should be turned to a minimum setting (full CCW).

FIG. 1 – AC LINE VOLTAGE JUMPER SETTING (J1A, J1B)

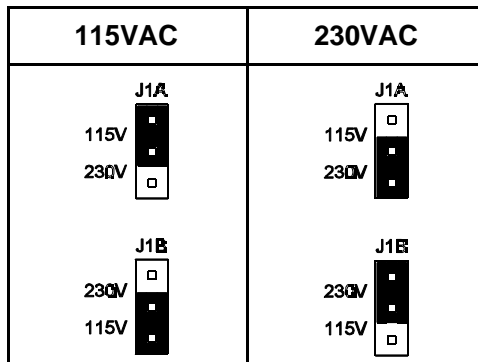

FIG. 2 – MOTOR ARMATURE VOLTAGE JUMPER SETTING (J3)

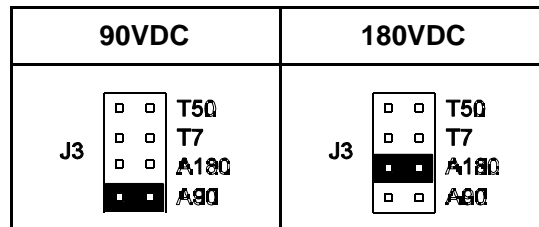

TABLE 5 – RELATIONSHIP of AC LINE INPUT AND MOTOR VOLTAGE with J1A, J1B and J3 JUMPER POSITION

AC LINE INPUT VOLTAGE	J1A, J1B POSITION	J3 POSITION	MOTOR VOLTAGE
115	115	90	90
230	230	180	180
230	230	90*	90*

*A 90VDC motor can be used with a 230VAC line (J3 set in “A90” position). However, speed range may be reduced and motor derating may be required.

- D. **J4 – Analog Input Voltage** – Jumper J4 is set to the “15V” position for potentiometer operation. If the control is to be operated from an *isolated* 0–±10VDC signal (see sec. V, F, p. 22.), set J4 to the “10V” position.

FIG. 3 – JUMPER J4 SETTING

Potentiometer Operation	Signal Following

- E. **J5 – Control Mode (Speed or Torque).**

- i. Speed (**SPD**) Mode – (Note: Factory setting of J5 is Speed mode.) In the speed control mode (J5 set to SPD), the KBMG-212D will provide variable speed control. The motor speed will be in direct proportion to the input signal. Both forward and reverse torque are used to stabilize motor speed. (See fig. 6, p. 13.)
- ii. Torque (**TRQ**) Mode – In the torque control mode (J5 set to TRQ), the KBMG-212D will vary the maximum motor torque as a function of the voltage input to terminals “SIG” (signal) and “COM” (common). This voltage can be derived from the wiper of the main potentiometer or from an *isolated* analog input (signal voltage following).

FIG. 4 – JUMPER J5 SETTING

Speed Mode	Torque Mode

11

If the motor torque is greater than the load torque, the motor will rotate. If no load is applied to the motor, the motor will rotate at a speed proportional to the torque setting as set by the main potentiometer (see fig. 7, p. 14). By using the ACCEL and DECEL trimpots, the application of torque can be made more gradual or less gradual as required by the application. A maximum torque can be established using the current selector jumper, J2, which can be further modified by using the FWD and REV CL trimpots.

- F. **J6 – Coast to Stop (CTS), Regenerate to Stop (RTS)** –

This function operates in conjunction with the Enable circuit, which is used to start and stop the control electronically. If the circuit connecting terminals “EN” and “COM” on terminal block TB1

are opened, the control will cause the motor to stop. When jumper J6 is in the factory position (**RTS**), the motor will regenerate to a stop.

If J6 is changed to the coast to stop (CTS) position, the motor will coast to a stop when the “EN” - “COM” circuit is opened.

Note: Control will not run unless a jumper or closed contact is connected between the “EN” and “COM” terminals.

FIG. 5 – JUMPER J6 SETTING

Coast to Stop	Regenerate to Stop

FIG. 6 – SPEED CONTROL MODE

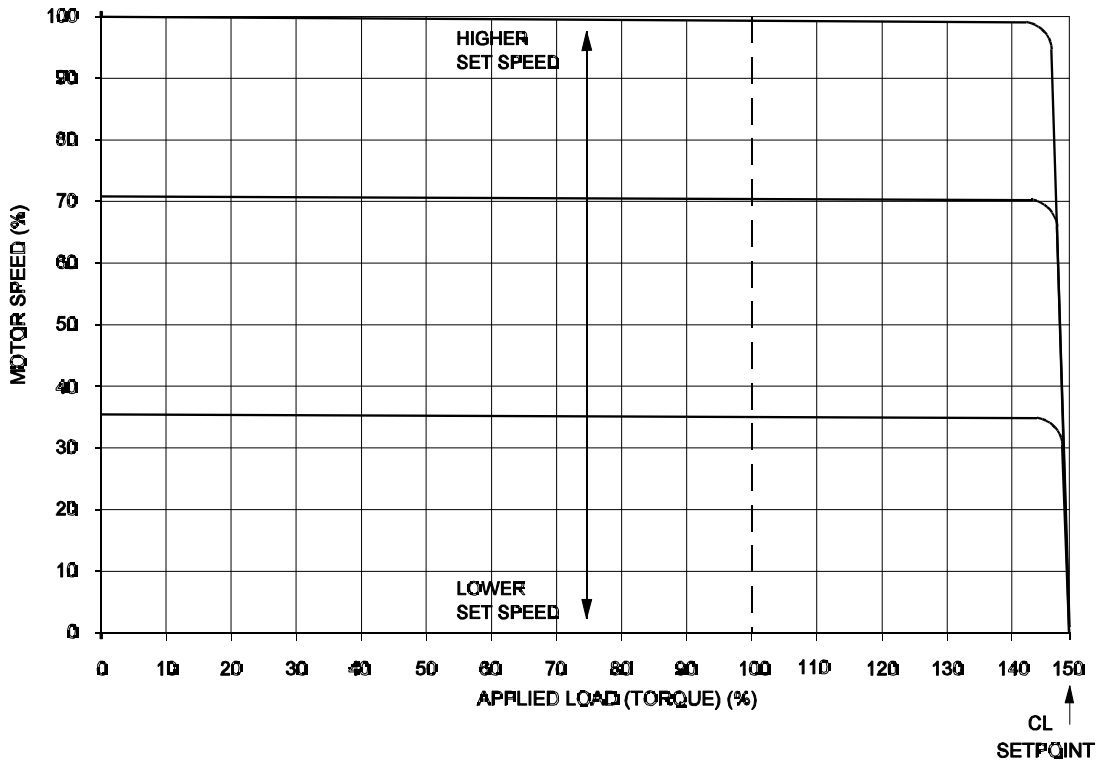

13

FIG. 7 – TORQUE CONTROL MODE (Linear)

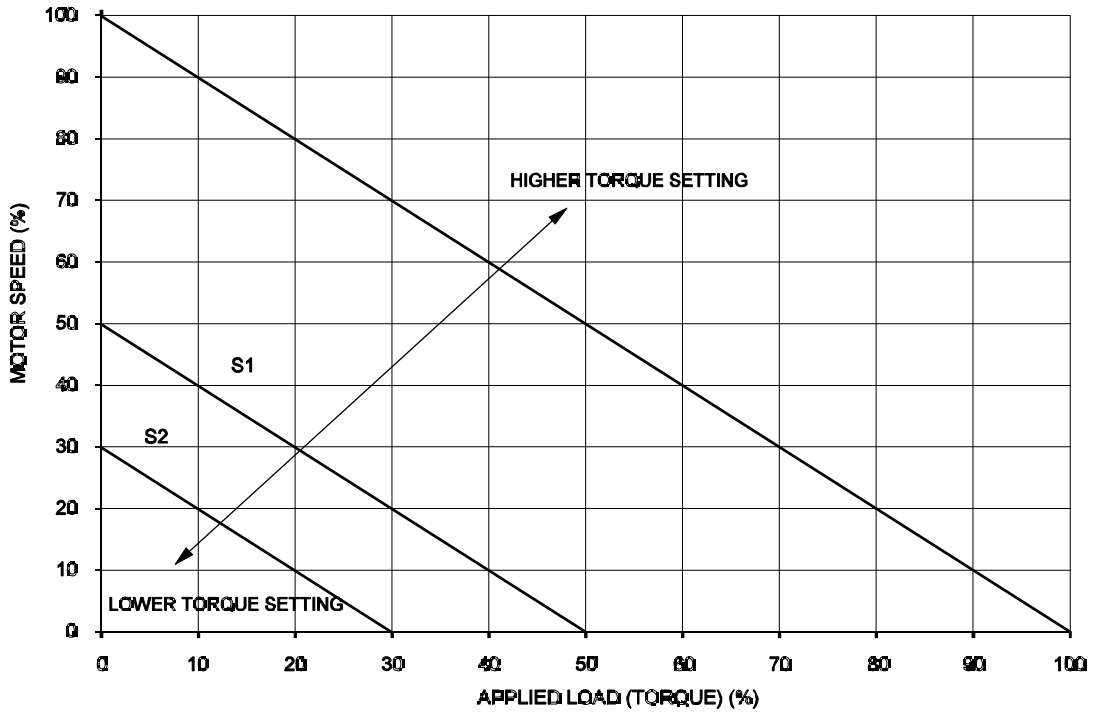

14

IV. MOUNTING.

Mount the KBMG-212D on a flat surface in an atmosphere free of moisture, metal chips, and corrosion. See Mechanical Specifications, fig. 13, p. 21. A 5K ohm remote speed potentiometer is provided with each control. Install potentiometer using hardware provided. Be sure to install insulating disk between potentiometer and inside of front panel.

Enclosure – When mounting the KBMG-212D in an enclosure, it must be large enough to allow the proper heat dissipation. A 12"12"12" enclosure is suitable when the control is not mounted on an auxiliary heatsink. A 12"12"24" enclosure is appropriate at full rating (11.0 amps) when the control is mounted on an auxiliary heatsink KB P/N 9861.

- V. **WIRING.**  Warning! Read Safety Warning before attempting to use this control.

Warning! To avoid erratic operation do not bundle AC line and motor wires with potentiometer, voltage following, enable, inhibit or other signal wiring. Use shielded cables on all signal wiring over 12" (30 cm) – Do not ground shield.

TABLE 6 – TERMINAL BLOCK WIRING INFORMATION

Terminal Block Designation	Connection Designation	Supply Wire Gauge		Maximum Tightening Torque (in-lbs)
		Minimum	Maximum	
TB1	Logic Connections	22	14	3.5

15

Wire control in accordance with National Electrical Code requirements and other local codes that apply. A "normal blo" 20 amp fuse or circuit breaker should be used on each AC line conductor that is not at ground potential (do not fuse neutral or grounded conductors). (See section VI, p. 24 for fuse information.) Wire control in accordance with connection diagrams (see figures 8, 9, 10A, 10B, 11 and 14 on pages 16, 17, 19 and 22). A separate AC line switch or contactor must be wired as a disconnect switch so that contacts open each ungrounded conductor of the control. See table 6 for terminal block wiring information.

FIG. 8 – AC LINE CONNECTION

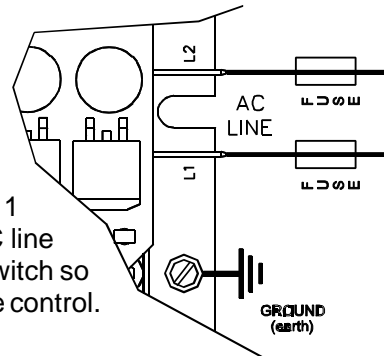

- A. **AC Line** – Connect AC Line to terminals L1 and L2. (Be sure jumpers J1A and J1B are set to match the AC line voltage used.) (See table 5, p. 10.)

- B. **Ground** – Be sure to ground (earth) control via green screw located on chassis.

 Do not ground any other terminals.

- C. **Motor Armature** – Connect motor armature to terminals M1 (+) and M2 (-). (Be sure jumper J3 is set to match motor voltage.) (See table 5, p. 10.)

FIG. 9 – ARMATURE CONNECTION

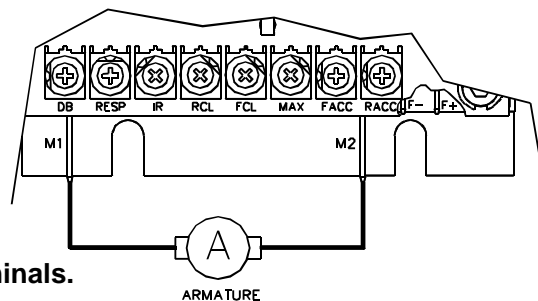

- D. Field – For Shunt Wound motors only.**
Do not use F+ and F– terminals for any other motor type. Connect motor shunt field to terminals F+ and F– for 90VDC motors with 100VDC fields and 180VDC motors with 200VDC fields. For motors with half voltage fields, 90VDC motors with 50VDC fields and 180VDC motors with 100VDC fields, connect field to terminals F+ and L1. See table 7, p. 18 for summary of field connections.

FIG. 10A – FULL VOLTAGE FIELD

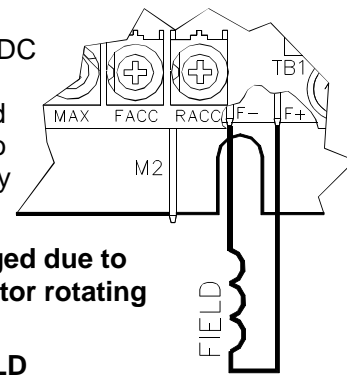

CAUTION – Shunt-Wound motors may be damaged due to overheating if field remains powered without motor rotating for an extended period of time.

FIG. 10B – HALF VOLTAGE FIELD

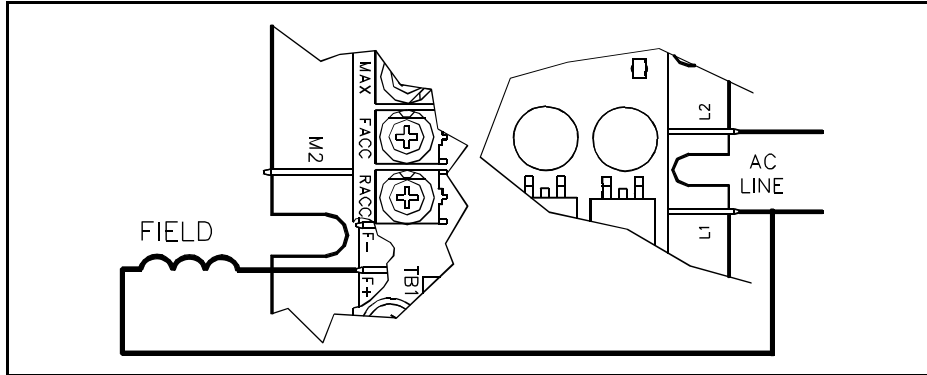

17

TABLE 7 – FIELD CONNECTIONS (Shunt Wound Motors Only)

AC Line Voltage (VAC)	Motor Voltage	Field Voltage (VDC)	Field Connection
115	90	100	F+, F–
115	90	50	F+, L1
230	180	200	F+, F–
230	180	100	F+, L1
230	90*	100	F+, L1

*Step Down operation (see sec. III C, p. 9).

- E. Main Speed Potentiometer** – The main speed potentiometer can be connected in several ways using terminals “COM,” “+15,” “SIG” and “–15.” A 5K ohm potentiometer is supplied with control. (A 10K potentiometer can also be used.)



(Warning! Terminals “COM,” “+15,” “SIG” and “–15” are not isolated from AC line.) Note: Jumper J4 must be in the “15V” position.

- i. **Unidirectional operation only** – Connect potentiometer to terminals “COM,” “+15,” “SIG” for forward direction. To operate in reverse direction, connect to “COM,” “SIG,” and “–15.” See fig. 11, p. 19.
- ii. **Bidirectional operation only** – Connect to terminals “COM,” “+15,” “SIG,” and “–15” when using reversing contacts. To operate with a potentiometer, connect to “+15,” “SIG,” and “–15.” See fig. 11.

FIG. 11 – MAIN SPEED POTENTIOMETER CONNECTIONS

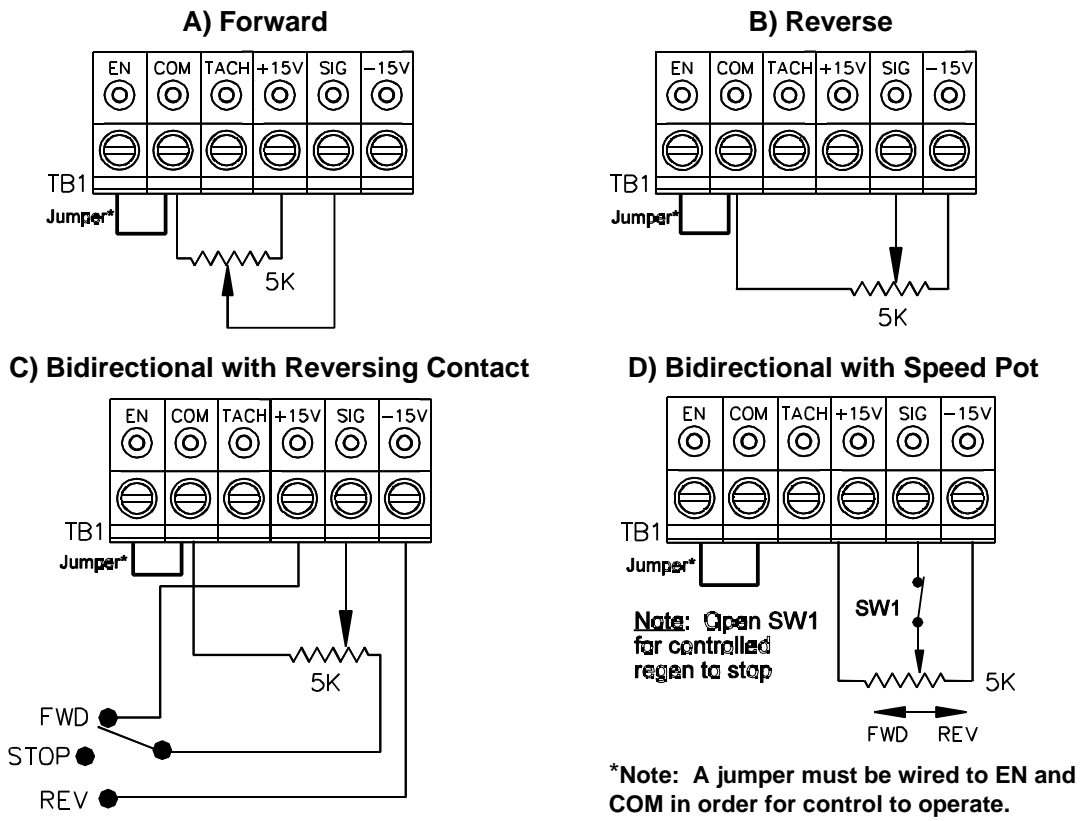

19

FIG. 12 – CONTROL LAYOUT

(Illustrates Factory Setting of Jumpers and Approximate Trimpot Settings)

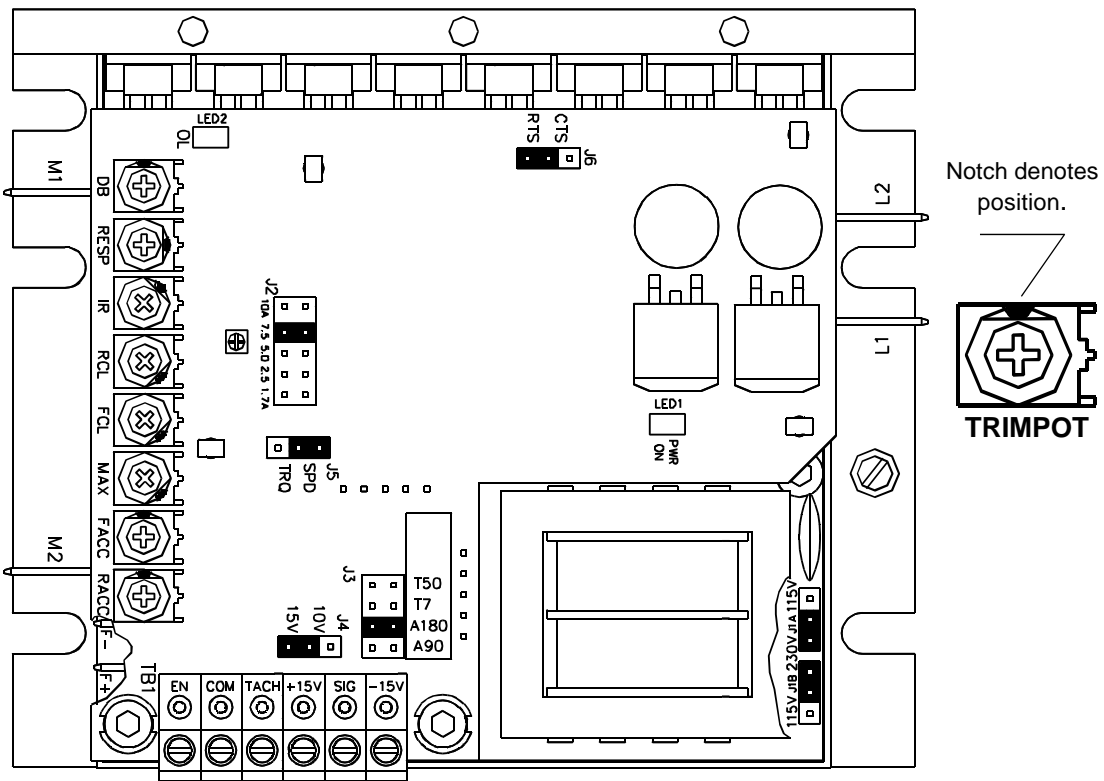
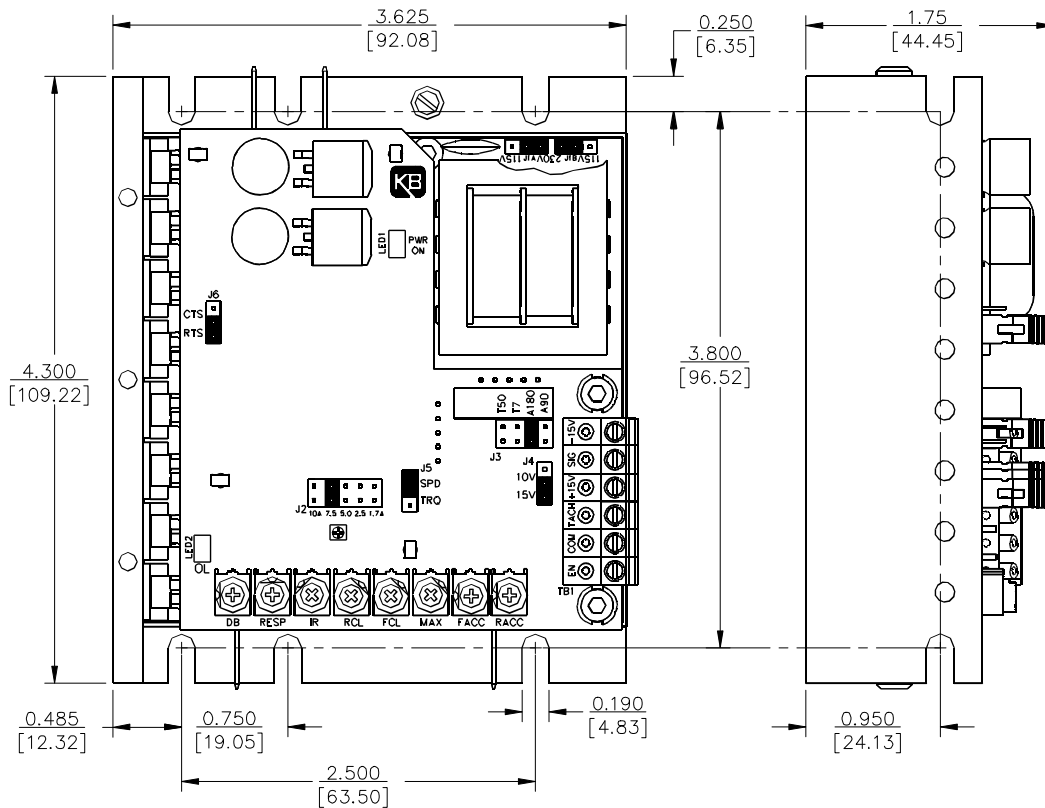

FIG. 13 – MECHANICAL SPECIFICATIONS (INCHES / [mm])



21

F. Voltage Following – An *isolated* analog voltage can be used in lieu of main speed potentiometer. Connect signal to terminals “SIG” and “COM.” Note: Terminal “COM” is common. A positive signal to terminal “SIG” will produce a positive output to motor. A negative signal to terminal “SIG” will produce a negative output. A 0 to ±10VDC is required to operate control from 0 ± full output. Note: Jumper J4 must be in the “10V” position. **Note: An isolated signal voltage must be used or catastrophic failure can result.** (A bipolar signal isolator, model SIMG [KB P/N 8832], is available as an option from your distributor.)

FIG. 14 – VOLTAGE FOLLOWING CONNECTION

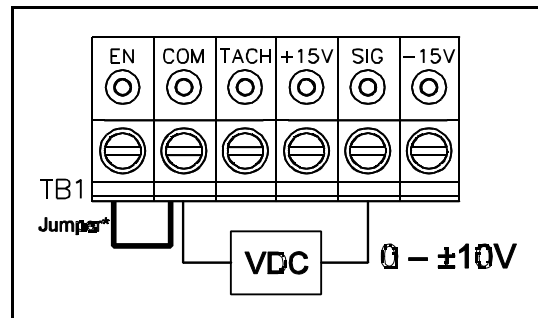

G. Enable Start/Stop Circuits – The KBMG-212D contains a 2-wire stop circuit (Enable), which is used to electronically bring the motor to a “stop.” An *isolated* single contact closure is required. If an isolated contact is not available, it may be necessary to use an isolation relay.

***Note: If 2-wire start/stop circuit is not used, a jumper must be wired to EN and COM or control will not operate.**



WARNING! Do not use Start/Stop or Enable functions as a safety disconnect. Use only an AC line disconnect for that purpose.

- i. **Regen to a stop using terminals EN and COM on terminal block TB1** – When a contact is opened between terminals “EN” and “COM,” with jumper J6 in the “RTS” position, the motor will regeneratively brake to a rapid stop. **Application note (See fig. 15):** If controlled regen to stop is required, a contact can be installed in series with the signal “SIG” connection. The braking time will be equal to the REV ACCEL setting when the motor is in the forward direction, and equal to the FWD ACCEL setting when the motor is in the reverse direction. Note: J4 must be in the “15V” position. (See fig. 11D, p. 19.)
- ii. **Coast to a stop using terminals “EN” and “COM” on terminal block TB1** – If coast to stop operation is required, move jumper J6 to the coast to stop (CTS) position. When the contact is opened between “EN” and “COM,” the motor will coast to a stop. See fig. 16.

FIG. 15 – REGENERATE TO STOP

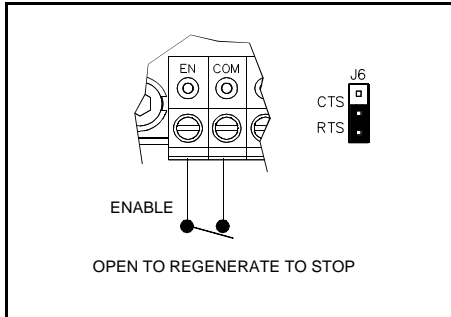
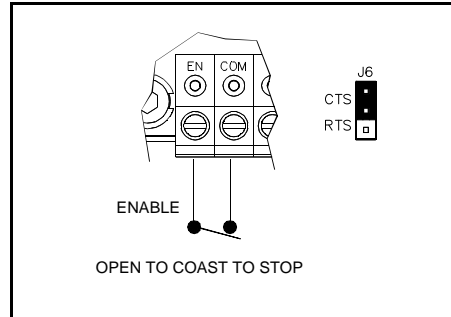

FIG. 16 – COAST TO STOP



*FWD Accel and REV Accel do not affect the stopping time when the enable circuit is opened.

23

- H. **Tach-generator Feedback** – The KBMG-212D is factory set for armature feedback, which provides good load regulation for most applications. For superior load regulation, analog tach-generator feedback can be used.

Wire the tach-generator so that the polarity of the tach-generator is the same with respect to the input signal polarity (see fig. 17).

Note: If tach-generator is wired with reverse polarity, the motor will run at full speed.

Note: Jumper J3 must be set to the proper position for tach feedback. See sec III, C, p. 9 and fig. 2 on page 10. **Note:** Check tach voltage polarity with respect to input signal if polarity does not match reverse tach leads.

FIG. 17 – TACH-GENERATOR FEEDBACK

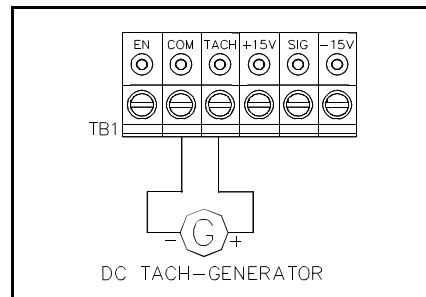

Be sure AC line is disconnected when rewiring tach-generator.

VI. FUSING.

Armature Fuse – It is recommended that the correct size armature fuse be installed, depending on the rating of the motor and form factor (RMS/AVG current). Fuse type should be Littelfuse 326 ceramic or Buss ABC, or equivalent. A fuse chart is presented below which suggests appropriate armature fuse ratings. However, the specific application may require larger fuse ratings based on ambient temperature, CL set point and duty cycle of operation (see table 8, p. 25). Fuses may be purchased from your distributor. Wire fuse in series with armature lead.

TABLE 8 – ARMATURE FUSE CHART

Motor Horsepower		Approx. DC Motor Current Amps	Fuse Rating (AC Amps)
90VDC	180VDC		
1/8	1/4	1.3	2
1/6	1/3	1.7	2
1/4	1/2	2.5	4
1/3	3/4	3.3	5
1/2	1	5.0	8
3/4	1	7.5	12
1	2	10.0	20

VII. TRIMPOT ADJUSTMENTS.

The KBMG-212D contains trimpots that have been factory adjusted for most applications. See specifications for factory settings. (Note: Fig. 12, p. 20, presents the various trimpots with their location. They are shown in the approximate factory position.) Some applications may require readjustment of trimpots in order to tailor control to exact requirements. Readjust trimpots as follows:

A. Forward Acceleration (FWD ACCEL) and Reverse Acceleration (REV ACCEL)

The FWD ACCEL trimpot determines the amount of time it takes the control voltage to reach full output in the forward direction. It also determines the amount of time it takes for the control voltage, in the reverse direction, to reach zero output. (FWD ACCEL is the Reverse Decel.)

The REV ACCEL trimpot determines the amount of time it takes the control voltage to reach full output in the reverse direction and the time it takes for the control voltage, in the forward direction, to reach zero output. (REV ACCEL is the Forward Decel.)

The FWD and REV ACCEL trimpots are factory adjusted to approximately 1 second. The acceleration times are adjustable over a range of 0.1 to 15 seconds. See fig. 18 for graphical representation of ACCEL.

Note: The FWD and REV CL trimpots may override the rapid accel and decel settings.

FIG. 18 – ACCEL TRIMPOT ADJUSTMENT

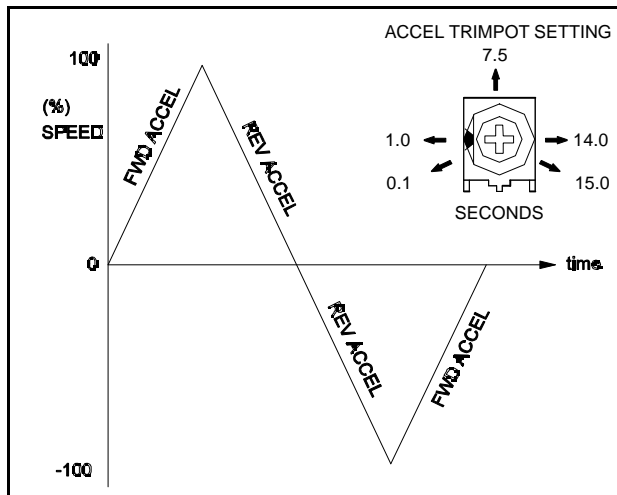

Note: A 4-quadrant ACCEL/DECEL accessory module (KB P/N 8834) is available as an option. It provides separate control of FORWARD acceleration and deceleration and REVERSE acceleration and deceleration.

- B. Dead Band Trimpot (DB) –**
The DB trimpot sets the amount of main speed potentiometer rotation or analog voltage input required to initiate control voltage output. It is factory adjusted to approximately 25% of rotation.

FIG. 19 – DEAD BAND TRIMPOT ADJUSTMENT

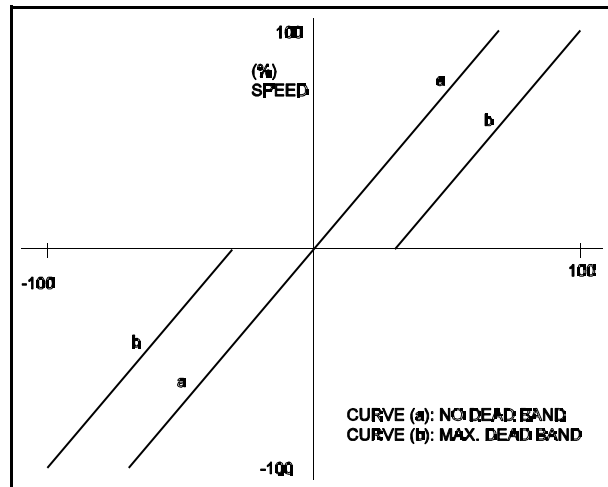

The DB trimpot also determines the amount of delay that will occur before regeneration starts. Regeneration occurs when the applied load torque is in the same direction as the motor rotation.

To readjust the DB to factory setting:

- i. Set Main Speed pot to zero speed position.
- ii. Set DB trimpot to full CCW position.

27

- iii. Adjust DB trimpot CW until motor hum is eliminated. (See fig. 19, p. 27 for graphic illustration of the DB trimpot.) **Note:** If the dead band trimpot is set too low (CCW direction), the motor may oscillate between forward and reverse. Adjust dead band trimpot CW until the instability disappears. (Oscillation may also occur due to RESP and IR COMP trimpot settings. See sec. VII, D & F on page 29.)

- C. Forward Current Limit (FWD CL) and Reverse Current Limit (REV CL) Trimpots –** These trimpots are used to set the maximum amount of DC current that the motor can draw in both the forward and reverse directions. The amount of DC current determines the amount of maximum motor torque. They are factory set at 150% of the current established by the jumper J2 setting.

Readjust the CL trimpot as follows:

- i. Turn CL trimpot to MIN (CCW) position. Be sure jumper J3 is in the proper position approximately equal to the motor DC ampere rating.
- ii. Wire in a DC ammeter in series with armature lead. Lock shaft of motor.
- iii. Apply power. Rotate CL trimpot quickly until desired CL setting is reached (factory setting is 1.5 times rated motor current). Be sure control is in forward direction for FWD CL trimpot adjustment and likewise with REV CL.

Warning! To prevent motor damage, do not leave motor shaft locked for more than 2 – 3 seconds.

Caution! Adjusting the CL above 150% of motor rating can cause overheating and demagnetization of some PM motors. Consult motor manufacturer.

- D. IR Compensation (IR Comp)** – The IR Comp is used to stabilize motor speed under varying loads. Readjust the IR Comp trimpot as follows:
- i. Initially set trimpot to factory position (approximately 10 o'clock).
 - ii. Run motor at approximately 30 – 50% of rated speed under no load and measure actual speed.
 - iii. Load motor to rated current. Rotate IR Comp trimpot so that loaded speed is the same as the unloaded speed measured in the previous step.
- Control is now compensated so that minimal speed change will occur over a wide range of motor load. **Note:** Excessive IR Comp will cause unstable (oscillatory) operation.
- E. Maximum Speed (MAX)** – The MAX trimpot is used to set the maximum output voltage of the control which, in turn, sets the maximum speed of the motor.
- Adjust the MAX trimpot as follows:
- i. Rotate Main Speed potentiometer to full speed (CW).
 - ii. Adjust MAX trimpot to desired maximum motor speed.
- Note: Do not exceed maximum rated RPM of motor since unstable operation may result.
- F. Response Trimpot (RESP)** – This trimpot determines the dynamic response of the control. The factory setting is approximately 50% of full rotation. The setting may be increased if a faster response is required. Note: If response is set too fast, unstable operation may result.

29

VIII. FUNCTION INDICATOR LAMPS.

- A. Power On (PWR ON)** – Indicates that the drive is energized with the AC line.
- B. Overload (OL)** – Indicates the control has reached the current limit set point which has been established by the position of jumper J2 and the FWD CL and REV CL trimpot settings. In transient load applications, it is normal for this light to blink.

IX. KBMG-212D ACCESSORIES

- **Model SIMG Bipolar Signal Isolator (P/N 8832)** – Allows a non-isolated signal source to be used.
- **Multi Speed Board (P/N 8833)** – Provides discrete preset speeds which can be controlled from a PLC.
- **4-Quadrant Accel/Decel (P/N 8834)** – Provides independent settings of forward accel, forward decel, reverse accel and reverse decel.
- **DIN Rail Mounting Kit (P/N 9995)** – Converts control to standard DIN Rail Mounting.

