

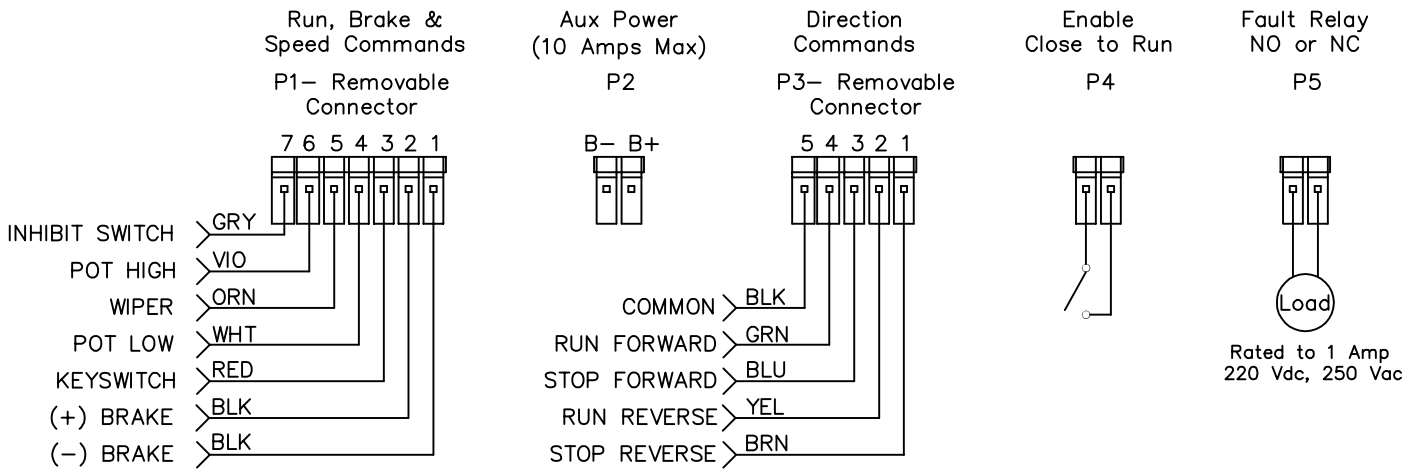

"The Right Control  
for your Application"

## KBBC-MICRO CONNECTION DIAGRAM

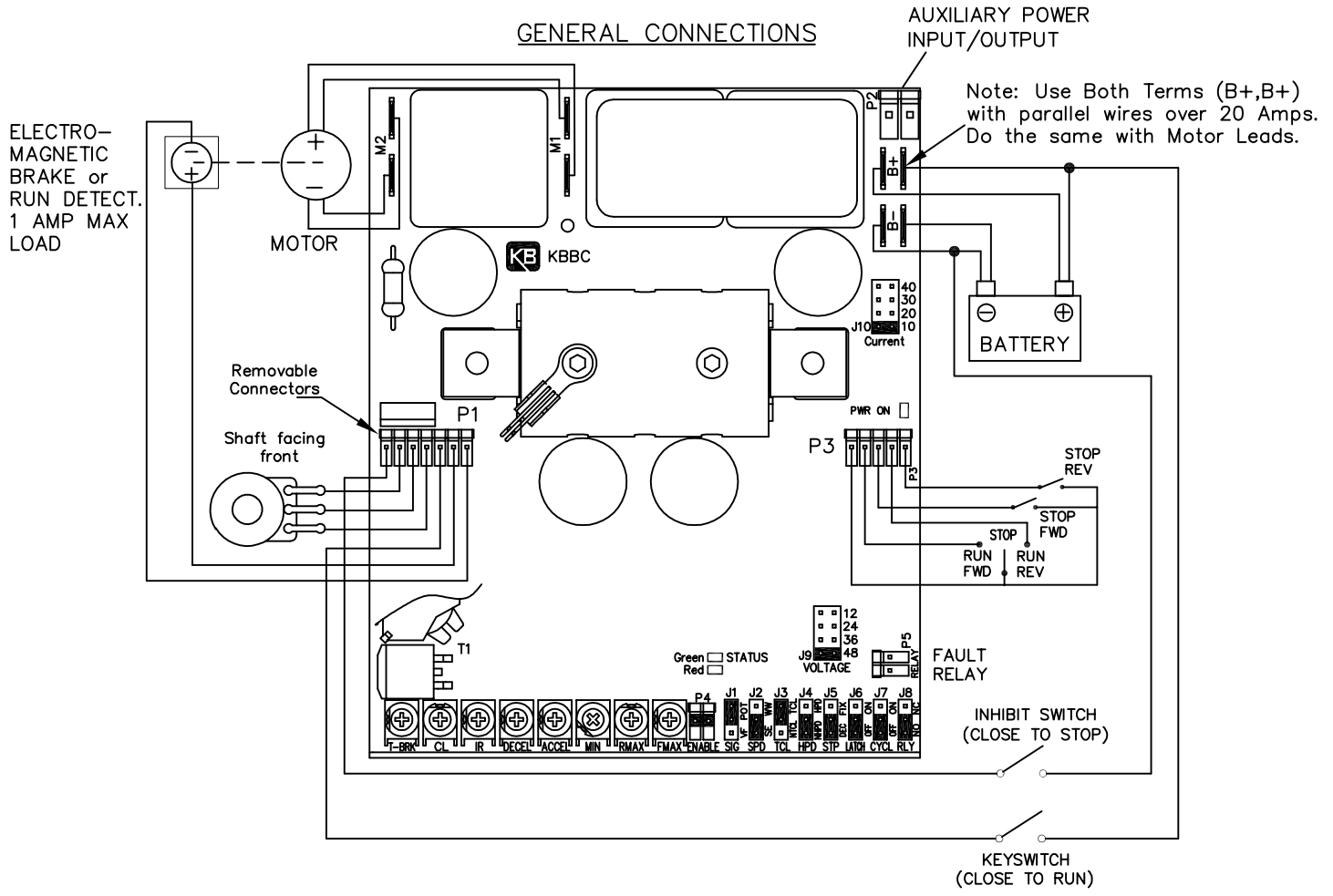

The information contained in these instructions is intended to be accurate. However, the manufacturer retains the right to make changes in design which may not be included herein. WF-9/25/03

## KBBC-MICRO FUNCTIONAL DESCRIPTIONS

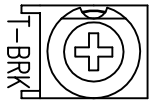

**TIMED BRAKE DELAY (T-BRK)**- This adjusts time delay before the brake engages after the drive is told to stop. Brake is initiated by Enable, or Keyswitch opening, or inhibit terminals closing.

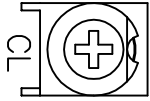

**CURRENT LIMIT (CL)**- Allows adjustability of current limit setpoint. Typically set at 1.5 X the Motor FLA. When Current Limit engages the status light will indicate by turning red.

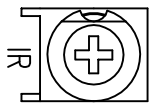

**IR COMPENSATION (IR)**- Allows adjustment of load compensation for different motors. Smaller motors require more compensation to overcome losses in armature winding. Typically set by checking No Load to Full Load speed changes.

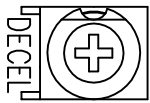

**DECELERATION (DECEL)**- Allows for controlled deceleration from full speed to zero speed, from 0.1 to 15 seconds as pot is turned clockwise. Decel works with all stop modes except inhibit. When inhibit is used the decel pot has no effect, output will go to zero in 0.1 seconds.

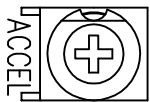

**ACCELERATION (ACCEL)**- Allows for controlled acceleration from zero to full speed. From 0.1 to 15 seconds as pot is turned clockwise. Accel is active in any turn on condition, including Enable, Keyswitch, or release of inhibit.

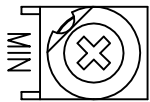

**MINIMUM SPEED (MIN)**- Sets the minimum speed the motor will run. Factory set to zero speed, but can be adjusted from 0-30% of full speed.

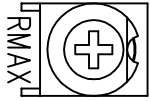

**MAXIMUM REVERSE SPEED (RMAX)**- Limits the maximum allowable speed in the reverse direction. Range is 50-100% of Forward speed (RMAX is dependant on FMAX setting).

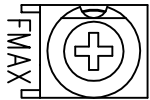

**MAXIMUM FORWARD SPEED (FMAX)**- Limits the maximum allowable speed in the forward direction. Range is 60-100 % of full speed. Set for Full Travel 5K Pot. For limited travel of Pot (ex. 1/4 rotation=desired full range), FMAX can be turned clockwise to compensate.

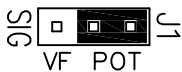

**SIGNAL JUMPER (J1)**- Voltage Following/ Potentiometer. Selects either potentiometer speed control, or remote 0-5 Vdc signal input. (See page 4).



**SPEED MODE JUMPER (J2)**- Wig Wag/ Single Ended. Allows for choice of Wig Wag speed control, (center of pot is zero speed, clockwise is forward, counter is reverse), or Single Ended, (contact closure chooses direction). (See page 4).

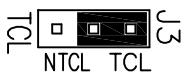

**TIMED CURRENT LIMIT JUMPER (J3)**- Non Timed Current Limit/ Timed Current Limit. Disables or enables the shutdown of the drive due to motor overcurrent after 7 seconds.



**HIGH PEDAL DISABLE JUMPER (J4)**- Non High Pedal Disable/ High Pedal Disable. In HPD the main speed pot needs to be reset to zero before motor is allowed to run.



**STOP MODE JUMPER (J5)**- Decel/ Fixed. Allows stop function (Enable, Keyswitch, Direction Command) to use deceleration trimpot for controlled stop, or fixed stop of 0.1 second.



**LATCH JUMPER (J6)**- Off/ On. Allows choice of how direction commands are activated. If latch is in "OFF" position, direction commands need to be maintained to run. If Latch is in the "ON" position, direction commands are momentary to run or stop. (See page 4).



**CYCLE (J7)**- Off/ On. When the drive is commanded to stop, an output relay closes to short motor leads together. This action will act like a dynamic brake and impede motor travel. If this action is not desired, the cycle jumper can be placed in the "ON" position. (see page 4).



# KBBC-MICRO FUNCTIONAL DESCRIPTIONS DIRECTION AND SPEED COMMAND SETTINGS

MODE SETTINGS	DIRECTIONAL SETTINGS		
	WIG-WAG MOMENTARY SWITCHING	SINGLE-ENDED MOMENTARY SWITCHING	MAINTAINED SWITCHING
CONNECTOR P3			
JUMPERS			

MODE SETTINGS	SPEED INPUT SETTINGS	
	VOLTAGE FOLLOWING	POTENTIOMETER CONTROL
CONNECTOR P1		
JUMPERS		

Notes:

- 1) Inhibit Function is used for immediate (0.1 sec) deceleration. Close to stop.
- 2) Keyswitch Function is used to enable power to the drive. "Power On" light will illuminate to indicate the keyswitch is activated.
- 3) Main speed potentiometer (included) is rated 5 Kohm, 1/3 watt, wirewound.
- 4) Wig-Wag applications typically use a spring return to center potentiometer (not supplied or available through KB Electronics).
- 5) Cycle Jumper (J7) - The mechanical life of a relay is 10 million cycles. The Cycle Jumper is useful for repetitive cycling ON/OFF. When in "OFF" position the relay will engage to brake. When in "ON" position it will not. This will limit the use of the relay.
- 6) Keyswitch Function is used to enable power to the drive. "Power On" light will illuminate to indicate the keyswitch is activated.

TABLE 1, SPEED INPUTS.

DIRECTION	INPUT SIGNAL (VDC)	
	WIGWAG	SINGLE END
MAXIMUM FORWARD	4.7 + 0.3	4.7 + 0.3 (RUN FWD SELECTED)
NEUTRAL	2.5 ± 0.3	0 + 0.3
MAXIMUM REVERSE	0 + 0.3	4.7 + 0.3 (RUN REV SELECTED)

- 7) Momentary Limit Switch bypass protection. If limit switch is engaged in either direction (Stop Fwd, Stop Rev), the same direction run command will not allow continued travel. Ex. Run Fwd, Stop Fwd, will not allow Run Fwd Command until Run Reverse is called. If indexing is required, (Momentary Run Fwd, Momentary Stop Fwd, then Momentary Run Fwd in same direction), the stop reverse (P3-1) must be connected to COM (P3-5), otherwise unit will not go forward the second time.