

**Installation and Operation Manual**

**KBDA SERIES**

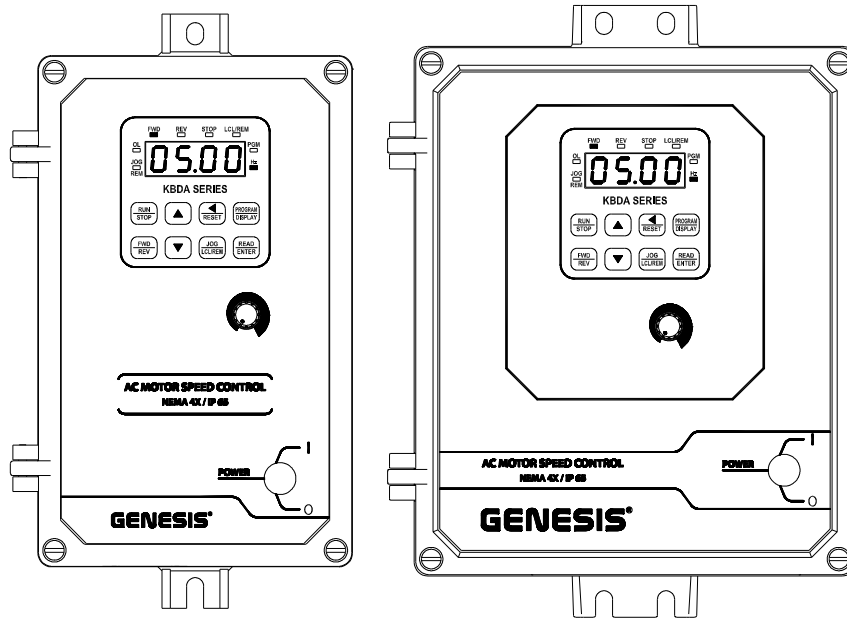
**ADJUSTABLE FREQUENCY DRIVES FOR 3-PHASE AC MOTORS  
NEMA-4X / IP-65**

**MULTI-FUNCTION KEYPAD WITH 4-DIGIT LED DISPLAY**  
• Simplified Group Programming • 8 LED Status Indicators

Washdown and Watertight for Indoor and Outdoor Use

**Rated for 208 – 230 and 400/460 Volt 50\* & 60 Hz  
3-Phase AC Induction Motors from Subfractional thru 5 HP**

**Operates from 115, 208/230, and 400/460 Volt 50/60 Hz AC Line<sup>1</sup>**



 See Safety Warning, on page 4.



This Manual Covers Models  
KBDA-24D, 27D, 29, 45, 48



**\*Note: The drive is factory set for 60 Hz motors. For 50 Hz motors, see Figure 15, on page 13.**

The information contained in this manual is intended to be accurate.  
However, the manufacturer retains the right to make changes in design, which may not be included herein.

**Notes: 1. Models KBDA-24D, 27D contain an AC line input voltage selection jumper. 2. All models are UL Listed for USA and Canada. 3. Requires CE approved RFI filter. See AC Line Filters, in Table 1, on page 6.**



**Automation and Control**

© 2007 KB Electronics, Inc.  
(see back cover)

# Preliminary KBDA Series Drives Installation and Operation Manual

## TABLE OF CONTENTS

Section	Page
1 Quick-Start Instructions .....	3
2 Safety Warning .....	4
3 Introduction.....	5
4 Important Application Information .....	9
5 Mounting Instructions.....	9
6 Electrical Connections .....	10
7 AC Line Input Voltage Selection (Jumper J1 (Models KBDA-24D, 27D Only)) .....	12
8 Recommended High Voltage Dielectric Withstand Testing (Hi-Pot Testing) .....	12
9 Drive Operation .....	13
10 Programmable Function Summary List.....	18
11 Diagnostic LEDs.....	24
Appendix A – Optional IODA Input/Output Multi-Function Board.....	25
Limited Warranty .....	32

Table	Page
1 Optional Accessories.....	6
2 General Performance Specifications.....	6
3 Electrical Ratings.....	6
4 Drive Terminal Block Wire and Tightening Torque Specifications .....	10
5 Multi-Function Output Relay "Run" and "Fault" Operating Modes.....	11
6 Keypad Description .....	13
7 Digital Readout Codes.....	17
8 Model Software Revision Code.....	18
9 LED Descriptions.....	24
10 IODA LED Status Indicators .....	25
11 IODA Terminal Block TB1 Wire and Tightening Torque Specifications.....	26
12 IODA Functions and Features .....	26
13 Preset Frequency Selection.....	27
14 Analog Input 1 Electrical Ratings .....	30
15 Analog Input 2 Electrical Ratings .....	30
16 Analog Outputs 1 and 2 Electrical Ratings.....	31
17 Multi-Function Open Collector Outputs Electrical Ratings .....	32

Figure	Page
1 Quick-Start Connection Diagram .....	3
2 Keypad Layout with Main Speed Potentiometer.....	7
3 Model KBDA-24D Drive Layout.....	7
4 Model KBDA-27D Drive Layout.....	7
5 Models KBDA-29, 45, 48 Drive Layout.....	8
6 Model KBDA-24D Mechanical Specifications.....	8
7 Models KBDA-27D, 29, 45, 48 Mechanical Specifications.....	8
8 Maximum Allowed Motor Torque vs. Speed.....	9
9 Open Ventilated Motor with External Fan Cooling.....	9
10 Models KBDA-24D, 27D AC Line Input, Motor, and Ground Connections.....	11
11 Models KBDA-29, 45, 48 AC Line Input, Motor, and Ground Connections .....	11
12 Multi-Function Output Relay Contacts.....	11
13 Model KBDA-24D AC Line Input Voltage Selection (Jumper J1).....	12
14 Model KBDA-27D AC Line Input Voltage Selection (Jumper J1).....	12
15 Typical Hi-Pot Test Setup .....	12
16 Flow Chart to Program the Drive for 50 Hz Motors.....	13
17 Flow Chart to Program Motor Current from 6.7 Amps to 5.5 Amps .....	14
18 Flow Chart to Change Set Frequency from 5.00 Hz to 43.21 Hz (Function 3.00) .....	14
19 Flow Chart to Program Accel Time Value from 1.5 Seconds to 120 Seconds (Function 3.03).....	15
20 Flow Chart to Program the Drive to Display Motor RPM (Function 4.00).....	15
21 Flow Chart to Program the Drive to Display Custom Units "012.0" (Functions 4.00 – 4.02).....	16
22 Flow Chart Showing Motor Current, Motor Voltage, and Bus Voltage Added to the Basic Display .....	17
23 Function No. Description .....	18
24 IODA Layout (All Models) .....	25
25 IODA Terminal Block TB1 Layout .....	26
26 Preset Frequency Selection Switch or Contact Connections and Function Settings .....	27
27 Up/Down Frequency Control Switch or Contact Connections and Function Settings.....	27
28 Accel/Decel 2 Switch or Contact Connection and Function Settings .....	28
29 Forward/Stop-Reverse/Stop Switch or Contact Connections and Function Settings.....	28
30 External Fault Auxiliary Equipment Switch or Contact Connection and Function Setting.....	28
31 Reset Switch or Contact Connection and Function Settings.....	29
32 2-Wire Start/Stop Switch or Contact Connection and Function Settings.....	29
33 3-Wire Start/Stop Switch or Contact Connection and Function Settings.....	29
34 Analog Input 1 Signal Voltage Following Connection and Function Settings .....	30
35 Analog Input 2 Signal Current Following Connection and Function Settings .....	30
36 Analog Outputs 1 and 2 Connections and Function Settings.....	31
37 Bidirectional Motor Operation Main Speed Potentiometer Connection and Function Setting .....	31
38 Multi-Function Output Relay Contacts Connections and Function Settings .....	32
39 Multi-Function Open Collector Connections and Function Settings .....	32

# Preliminary KBDA Series Drives Installation and Operation Manual

**Items Included In this Package:** KBDA Adjustable Frequency Drive, KBDA Series Installation and Operation Manual, CE Approved Product Information Card, Warranty Registration Card, and Mounting Template.

## IMPORTANT APPLICATION INFORMATION

- 50 Hz Motors:** This drive has been factory programmed to operate 60 Hz motors. For 50 Hz motor operation, set Function 0.00 to "0001". See Figure 15, on page 13.
- Motor Current Setting:** The motor current for all drive models is factory set to the maximum drive rating, as shown in Table 3, on page 6. In order for the motor overload protection to operate properly, the drive must be reprogrammed to the actual motor nameplate current. Use Function 0.01 to enter the motor nameplate current. See Figure 16, on page 14.
  - Model KBDA-27D:** Has a maximum current rating of 6.7 Amps (2 HP (1.5 kW)) when used with a 208 – 230 Volt 50/60 Hz AC line input (factory setting of motor current and AC line input voltage). When used with 115 Volt 50/60 Hz AC line input (Jumper J1 installed in the "115V" position), the maximum rating of the drive is 5.5 Amps (1½ (1.13 kW)). Be sure to reprogram the motor current (Function 0.01) to the actual motor nameplate current rating (not to exceed 5.5 Amps).
  - Model KBDA-29:** Has a maximum rating of 9.0 Amps (3 HP (2.25 kW)) when used with a 208 – 230 Volt 50/60 Hz 3-phase AC line input. When used with a 208 – 230 Volt 50/60 Hz single-phase AC line input, the maximum rating of the drive is 6.7 Amps (2 HP (1.5 kW)). Be sure to reprogram the motor current (Function 0.01) to the actual motor nameplate current rating (not to exceed 6.7 Amps).

## 1 QUICK-START INSTRUCTIONS

**Important:** You must read these simplified instructions before proceeding. These instructions are to be used as a reference only and are not intended to replace the details provided herein. You must read the Safety Warning on, page 9, before proceeding.

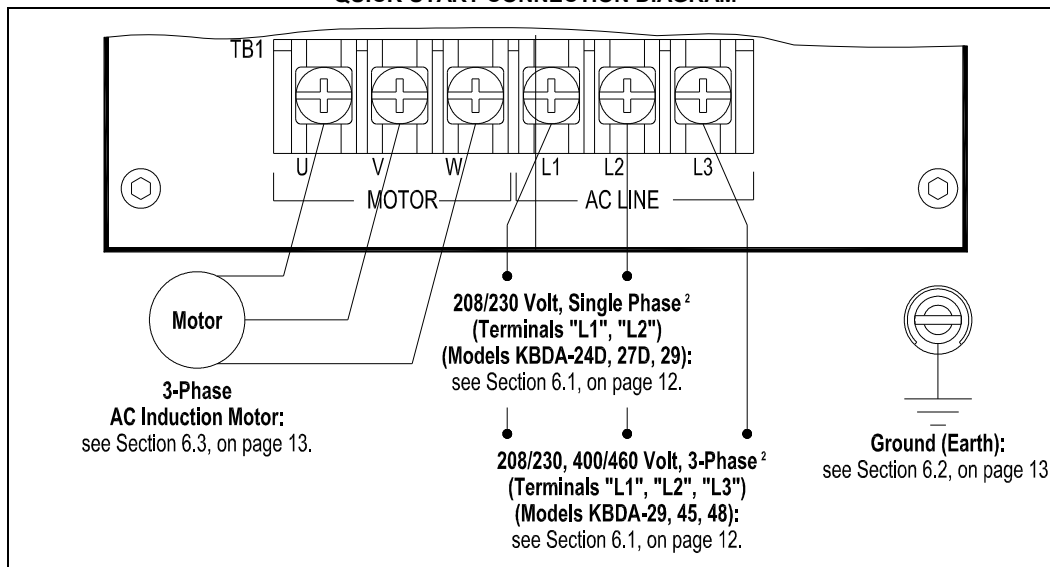
**Note:** This drive contains bus capacitors, which must be reconditioned if the drive has been in storage for over 1 year. To recondition the bus capacitors, apply the AC line, with the drive in the Stop Mode, for a minimum of 30 minutes.

See Figure 1. Also see Section 4 - Important Application Information, on page 9.



**WARNING!** Disconnect main power before making connections to the drive.

**FIGURE 1**  
**QUICK-START CONNECTION DIAGRAM<sup>1</sup>**



**Notes:** 1. Layout of Models KBDA-24D, 27D vary slightly. 2. 50/60 Hz AC line input.

# **Preliminary KBDA Series Drives Installation and Operation Manual**

- 1.1 AC LINE INPUT CONNECTION:** Connect the AC line input to Terminal Block TB1. See Section 6.1, on pages 10 and 11.

**Application Note:** If operation with a Ground-Fault Circuit-Interrupter (GFCI) is required, see Function 0.04, on page 21.

**Note:** The rated AC line voltage of the drive must match the actual AC line input voltage. On Models KBDA-24D, 27D, the setting of Jumper J1 must match the AC line input voltage.

**Model KBDA-24D:** Terminals "L1", "L2" – Designed for single-phase AC line input only. Rated for 208/230 Volt AC line input with Jumper J1 set to the "230V" position (factory setting) and rated for 115 Volt AC line input with Jumper J1 set to the "115V" position. See Figure 9, on page 11. **Note:** 230 Volts AC will be applied to the motor with 115 Volt AC line input.

**Model KBDA-27D:** Terminals "L1", "L2" – Designed for single-phase AC line input only. Rated for 208/230 Volt AC line input with Jumper J1 set to the "230V" position (factory setting) and rated for 115 Volt AC line input with Jumper J1 set to the "115V" position. Rated for 1½ HP maximum with 115 Volt AC line input and 2 HP maximum with 208/230 Volt AC line input. See Figure 9, on page 11. **Note:** 230 Volts AC will be applied to the motor with 115 Volt AC line input.

**Model KBDA-29:** Terminals "L1", "L2", "L3" – Designed for single-phase or 3-phase AC line input. Rated for 208/230 Volt AC line input only. Rated for 2 HP maximum with single-phase AC line input (Terminals "L1", "L2") and 3 HP maximum with 3-phase AC line input (Terminals "L1", "L2", "L3"). See Figure 10, on page 11.

**Models KBDA-45, 48:** Terminals "L1", "L2", "L3" – Designed for 3-phase AC line input only. Rated for 400/460 Volt AC line input only. See Figure 10, on page 11.

- 1.2 AC LINE FUSING:** It is recommended that a fuse(s) or circuit breaker be installed in the AC line. Fuse each conductor that is not at ground potential. For the recommended fuse size, see Table 3, on page 6. Also see Section 6.1, on pages 10 and 11.
- 1.3 GROUND CONNECTION:** Connect the ground wire (earth) to the ground screw, as shown in Figures 9 and 10, on page 11. Be sure the motor is also properly grounded.
- 1.4 MOTOR CONNECTION:** Connect the motor to Terminal Block TB1 Terminals "U", "V", "W", as shown in Figures 9 and 10, on page 11. Be sure the motor is properly grounded. Motor cable length should not exceed 100 ft. (30 m) – special reactors may be required – consult our Sales Department. See Section 6.3, on page 11.
- 1.5 60 Hz and 50 Hz MOTOR OPERATION:** The drive is factory set for 60 Hz motors (Function 0.00 set to "0000"). For 50 Hz motors, set Function 0.00 to "0001", as shown in Figure 15, on page 13. For other motor frequencies, set Function 0.00 to "0002".
- 1.6 JUMPER J1 SETTING (Models KBDA-24D, 27D Only):** Jumper J1 has been factory set for 230 Volt AC line input (installed in the "230V" position). For 115 Volt AC line input, set Jumper J1 to the "115V" position. See Section 7, on page 12.
- 1.7 MOTOR OVERLOAD PROTECTION:** Function 0.01 must be set to the motor nameplate current for proper operation of the I<sup>2</sup>t Motor Overload Protection.

## **2 SAFETY WARNING**

### **Definition of Safety Warning Symbols**



**Electrical Hazard Warning Symbol:** Failure to observe this warning could result in electrical shock or electrocution.



**Operational Hazard Warning Symbol:** Failure to observe this warning could result in serious injury or death.



This product should be installed and serviced by a qualified technician, electrician, or electrical maintenance person familiar with its operation and the hazards involved. Proper installation, which includes electrical connections, fusing or other current protection, and grounding, can reduce the chance of electrical shocks, and/or fires, in this product or products used with this product, such as electric motors, switches, coils, solenoids, and/or relays. Do not use this drive in an explosion-proof application. Eye protection must be worn and insulated adjustment tools must be used when working with drive under power. This product is constructed of materials (plastics, metals, carbon, silicon, etc.) which may be a potential hazard. Proper shielding, grounding, and filtering of this product can reduce the emission of radio frequency interference (RFI) which may adversely affect sensitive electronic equipment. It is the responsibility of the equipment manufacturer and individual installer to supply this Safety Warning to the ultimate end user of this product. (SW 1/2006)

The drive contains electronic Start/Stop circuits, which can be used to start and stop the drive. However, these circuits are never to be used as safety disconnects since they are not fail-safe. Use only the AC line for this purpose.

Be sure to read and follow all instructions carefully. Fire and/or electrocution can result due to improper use of this product.



This product complies with all CE directives pertinent at the time of manufacture. Contact our Sales Department for Declaration of Conformity. Installation of a CE approved RFI filter is required. See RFI Filters & Chokes Selection Guide D-321 (Part No. A42027) for the selection of filters to meet the Industrial or Residential Standard. Additional shielded cable and/or AC line cables may be required along with a signal isolator (IODA Input/Output Multi-Function Board (Part No. 9668)).

# **Preliminary KBDA Series Drives Installation and Operation Manual**

## **3 INTRODUCTION**

Thank you for purchasing the KBDA Adjustable Frequency Drive. KB Electronics, Inc. is committed to providing total customer satisfaction by producing quality products that are easy to install and operate.

The KBDA Adjustable Frequency Drives are variable speed controls housed in a rugged NEMA-4X / IP-65 washdown and watertight die-cast aluminum enclosure. They are designed to operate 208 – 230 and 400/460 Volt 50 & 60 Hz 3-phase AC induction motors from subfractional thru 5 HP. The sine wave coded Pulse Width Modulated (PWM) output provides high motor efficiency and low noise. Adjustable Linear Acceleration and Deceleration make the drive suitable for soft-start applications.

Due to its user-friendly design, the KBDA is easy to install and operate. Setting the drive to specific applications is accomplished using the Multi-Function Keypad, which provides easy operation and programming of the drive. To facilitate programming, all similar functions are presented in common groups. For more advanced programming, PC based Drive-Link™ software is available.

The 4-Digit LED Display provides readout of drive operating parameters and programming functions and displays Output Frequency, Motor RPM, Output Current, Output Voltage, Bus Voltage, Function Codes and Values, Fault Codes, and Custom Units. In addition to operating the drive, the Multi-Function Keypad is used to change drive operating parameters, reprogram functions, and change the display output. The LEDs provide indication of the drive's status and operating mode (Hz, PGM, LCL/REM, STOP, FWD, REV, OL, JOG/REM).

The optional IODA Multi-Function Board can be used for input signal isolation, isolated output voltage for controlling auxiliary devices, open collector outputs, and output relay contacts. See Appendix A, on pages 25 – 32. See Function Groups 7 – 9, on pages 21 and 22.

**Main Features:** Adjustable RMS Current Limit and I<sup>2</sup>t Motor Overload Protection.\* Adjustable Flux Vector Compensation with Static Auto-Tune and Boost provides high torque and excellent load regulation over a wide speed range. Power Start™ delivers over 200% motor torque to ensure startup of high frictional loads. Programmable Injection Braking provides rapid motor stop. Electronic Inrush Current Limit (EICL™) eliminates harmful AC line inrush current. A Multi-Function Output Relay is provided, which can be used to turn on or off equipment or to signal a warning if the drive is put into various modes of operation. Models KBDA-29\*\*, 45, 48 also contain AC Line Phase Loss Detection. The drive is suitable for machine or variable torque (HVAC) applications.

**Standard Front Panel Features:** 4-Digit LED Display, Multi-Function Keypad, Status Indicator LEDs, and a Main Speed Potentiometer.

**Optional Accessories:** On/Off AC Line Switch, Class "A" AC Line Filter, Input/Output Multi-Function Board, Programming Kit, Modbus Communication Module, and Liquidtight Fittings. See Table 1, on page 6.

*\*UL approved as an electronic overload protector for motors.*

*\*\*When used on 3-phase AC line input set for 7.0 Amps or higher (3 HP (2.25 kW)).*

### **3.1 STANDARD FEATURES**

- **Industrial Duty Die-Cast Aluminum Enclosure with Hinged Cover:** Available in dark gray finish or FDA approved white finish.
- **Multi-Function Keypad:** The keys are used to operate the drive, change operating parameters, reprogram functions, and change the display output (Run/Stop, Forward/Reverse, Up, Down, Shift/Reset, Jog-Local/Remote, Program/Display, Read/Enter).
- **4-Digit LED Display:** Provides readout of drive operating parameters and programming functions. Displays Output Frequency, Motor RPM, Output Current, Output Voltage, Bus Voltage, Function Codes and Values, Fault Codes, and Custom Units.
- **LED Status Indicators:** The LEDs provide indication of the drive's status and operating mode (Hz, PGM, LCL/REM, STOP, FWD, REV, OL, JOG/REM).
- **Multi-Function Output Relay Contacts:** Can be used to turn on or off equipment or to signal a warning if the drive is put into various modes of operation. (The optional IODA Input/Output Multi-Function Board contains 9 digital and analog inputs, 4 digital and analog outputs, and 2 additional relay outputs.)
- **Motor Current Selection:** Programmable motor current allows the drive to be used on a wide range of motor horsepower.
- **Compatible with GFCIs.** See Function 0.04, on page 19.

### **3.2 PERFORMANCE FEATURES**

- **Power Start™** – Provides more than 200% starting torque which ensures startup of high frictional loads.
- **Adjustable Flux Vector Compensation with Static Auto-Tune and Boost** – Provides excellent load regulation over a wide speed range.
- **Speed Range – 60:1**

### **3.3 PROTECTION FEATURES**

- **Motor Overload (I<sup>2</sup>t) with RMS Current Limit:** Provides motor overload protection, which prevents motor burnout and eliminates nuisance trips.\*
- **Electronic Inrush Current Limit (EICL™):** Eliminates harmful inrush AC line current during startup.
- **Short Circuit:** Shuts down the drive if a short circuit occurs at the motor (phase-to-phase).
- **AC Line Phase Loss Detection** (Models KBDA-29\*\*, 45, 48 only.)
- **Decel Extend:** Eliminates tripping due to bus overvoltage caused by rapid deceleration of high inertial loads.
- **Undervoltage and Overvoltage:** Shuts down the drive if the AC line input voltage goes below or above the operating range.
- **MOV Input Transient Suppression.**
- **Microcontroller Self Monitoring and Auto-Reboot.**

*\*UL approved as an electronic overload protector for motors.*

*\*\*When used on 3-phase AC line input set for 7.0 Amps or higher (3 HP (2.25 kW)).*

# Preliminary KBDA Series Drives Installation and Operation Manual

**TABLE 1**  
**OPTIONAL ACCESSORIES**

Description	Accessory Part No.				
	Model KBDA-24D	Model KBDA-27D	Model KBDA-29	Model KBDA-45	Model KBDA-48
<b>On/Off AC Line Switch:</b> Disconnects the AC line. Mounts on the enclosure cover and is supplied with a switch seal to maintain liquid-tight integrity.	9482	9523	9532	9532	9532
<b>AC Line Filter<sup>1</sup>:</b> Provides Class A Industrial Standard RFI (EMI) suppression. Installs onto the drive's PC board with quick-connect terminals.	9507	9512	9479	9479	9479
Suffix "S"					
<b>Suffix "S":</b> Filter must be used with built-in On/Off AC Line Switch.	9507	9512	9515	9515	9515
<b>Suffix "NS":</b> Filter must be used without On/Off AC Line Switch.					
<b>IODA Input/Output Multi-Function Board:</b> Provides signal isolation, isolated output voltage for controlling auxiliary devices, open collector outputs, and output relay contacts. Mounts on the drive's PC board with two snap-ins (located on the bottom of the mounting base) and two screws (provided).	9668	9668	9668	9668	9668
<b>Programming Kit:</b> Includes Download Module™ (DLM) handheld programming device, which uploads and downloads drive programs, PC to DLM serial and USB communication cables, DLM to inverter communication cable, and PC Windows® based Drive-Link™ communication software.	9582	9582	9582	9582	9582
<b>DIAC Modbus Communication Module:</b> Allows direct communication between drive and Modbus <sup>2</sup> protocol.	9517	9517	9517	9517	9517
<b>Liquidtight Fittings:</b> Provide a liquidtight seal for wiring the drive. Kit includes two ½" and one ¾" liquidtight fittings.	9526	9526	9526	9526	9526

**Notes:** 1. Complies with CE Council Directive 89/336/EEC Industrial Standard. 2. Other protocols available, contact our Sales Department.

**TABLE 2**  
**GENERAL PERFORMANCE SPECIFICATIONS**

Description	Specification	Factory Setting
115 Volt AC Line Input Voltage Operating Range (Volts AC)	115 (± 15%)	—
208/230 Volt AC Line Input Voltage Operating Range (Volts AC)	208 (-15%) / 230 (+15%)	—
400/460 Volt AC Line Input Voltage Operating Range (Volts AC)	380 (-15%) – 460 (+15%)	—
Maximum Load (% of Current Overload for 2 Minutes)	150	—
Switching Frequency (kHz)	8, 10, 12	8
Signal Following Input Voltage Range <sup>1</sup> (Volts DC)	0 – 5	—
Output Frequency Resolution (Bits, Hz)	10, .06	—
Minimum Operating Frequency at Motor (Hz)	0.3	—
Acceleration Time (Seconds)	0.1 – 180.0	1.5
Deceleration Time (Seconds)	0.3 – 180.0	1.5
Speed Range (Ratio)	60:1	—
Speed Regulation (30:1 Speed Range, 0 – Full Load) (% Base Speed) <sup>2</sup>	2.5	—
Overload Protector Trip Time for Stalled Motor (Seconds)	6	—
Undervoltage/Overvoltage Trip Points for 115 Volt AC Line Input (± 5%) (Volts AC) <sup>3</sup>	76 – 141	—
Undervoltage/Overvoltage Trip Points for 208/230 Volt AC Line Input (± 5%) (Volts AC) <sup>3</sup>	151 – 282	—
Undervoltage/Overvoltage Trip Points for 400/460 Volt AC Line Input (± 5%) (Volts AC) <sup>3</sup>	302 – 567	—
Run/Fault Output Relay Contact Rating (Amps at 30 Volts DC, 125 Volts AC, 250 Volts AC)	1, 0.5, 0.25	—
Operating Temperature Range (°C / °F)	0 – 45 / 32 – 113	—

**Notes:** 1. IODA option board required. 2. Dependent on motor performance. 3. Do not operate the drive outside the specified AC line input voltage operating range.

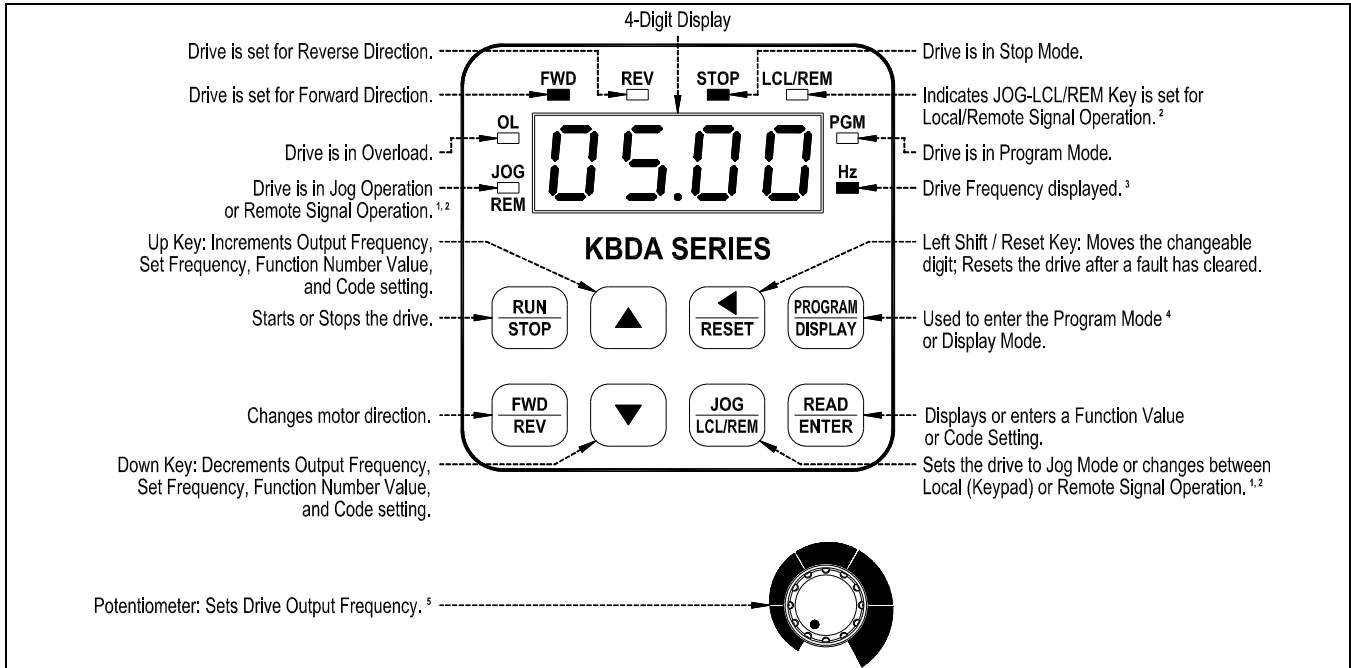
**TABLE 3**  
**ELECTRICAL RATINGS<sup>1</sup>**

Model	Part No. (Gray / White <sup>2</sup> )	AC Line Input			Fuse or Circuit Breaker Rating (Amps AC)	Output			Net Wt. lbs   kg	
		Volts AC (50/60 Hz)	Phase (Φ)	Maximum Current (Amps AC)		Voltage Range (Volts AC)	Maximum Continuous Load Current <sup>3</sup> (RMS Amps/Phase)	Maximum Horsepower (HP (kW))		
KBDA-24D <sup>4</sup>	9536 / 9537	115	1	16	20	0 – 230	3.6	1 (.75)	5.9	2.7
		<b>208/230</b>	1	10	15					
KBDA-27D <sup>4,5</sup>	9543 / 9544	115	1	22	25	0 – 230	5.5	1½ (1.13)	10.3	4.7
		<b>208/230</b>	1	15	20	0 – 230	<b>6.7<sup>3</sup></b>	2 (1.5)		
KBDA-29 <sup>6,7</sup>	9545 / 9546	208/230	1	15	20	0 – 230	6.7	2 (1.5)	10.3	4.7
			3	10.8	15	0 – 230	<b>9.0<sup>3</sup></b>	3 (2.25)		
KBDA-45 <sup>7,8</sup>	9659 / 9660	400/460	3	5.3	10	0 – 400/460	4.6	3 (2.25)	10.3	4.7
KBDA-48 <sup>7,8</sup>	9661 / 9662	400/460	3	9.6	10	0 – 400/460	8.3	5 (3.75)	10.3	4.7

**Notes:** 1. Bold indicates factory setting. 2. White FDA approved finish. 3. Factory setting of motor current (Function 0.01). 4. Models KBDA-24D, 27D contain an AC line input voltage selection jumper. 5. Model KBDA-27D is rated 1½ HP with 115 Volt AC line input and 2 HP with 208/230 Volt AC line input. 6. Model KBDA-29 is rated 2 HP with single-phase AC line input and 3 HP with 3-phase AC line input. 7. Also contain AC Line Phase Loss Detection (Model KBDA-29: when used on 3-phase AC line input set for 7.0 Amps or higher (3 HP (2.25 kW))). 8. Models KBDA-45, 48 are rated 0 – 400 Volts AC for 50 Hz motor operation and 0 – 460 Volts AC for 60 Hz motor operation.

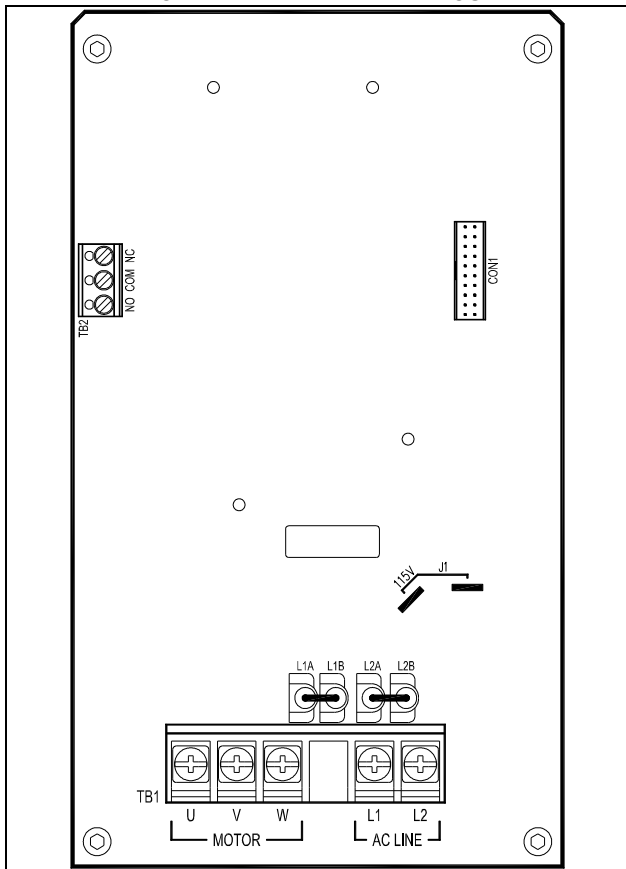
# Preliminary KBDA Series Drives Installation and Operation Manual

**FIGURE 2**  
KEYPAD LAYOUT WITH MAIN SPEED POTENTIOMETER

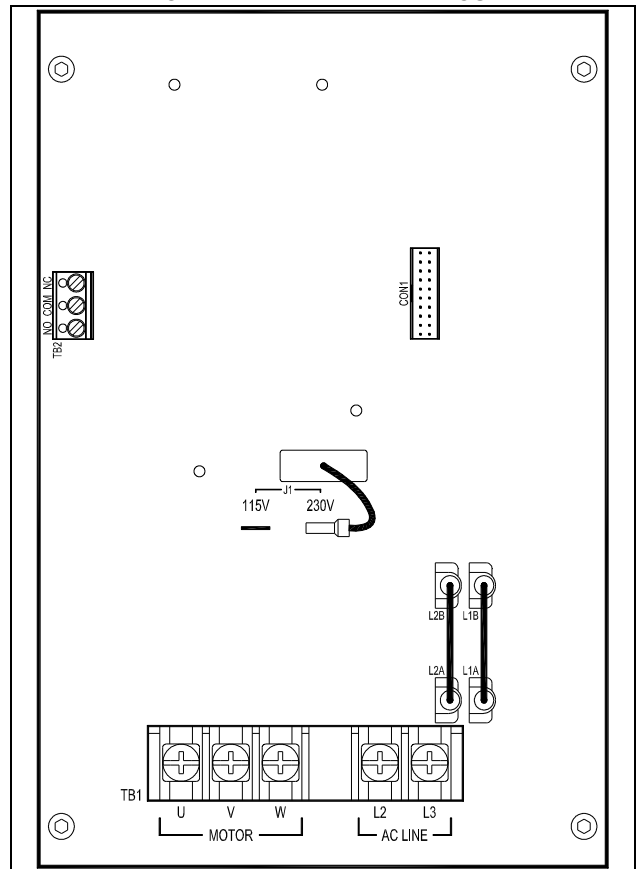


**Notes:** 1. The JOG-LCL/REM Key is factory programmed to function as a Jog Key. When the JOG-LCL/REM Key is pressed, the "JOG/REM" LED will illuminate and the display will show the Jog Frequency Setting (see Function 3.13, on page 20). 2. If the JOG-LCL/REM Key is reprogrammed for Local (Keypad) and Remote Signal Operation (see Function 2.02, on page 20), the "LCL/REM" LED will illuminate. Pressing the JOG-LCL/REM Key will toggle between Local (Keypad) and Remote Signal Operation. When Remote Signal Operation is selected, the "JOG/REM" LED will flash. The optional IODA (Part No. 9668) is required for remote signal operation. 3. The "Hz" LED will illuminate when the display is set to show Output Frequency. 4. If the PROGRAM/DISPLAY Key is pressed while Set Frequency is displayed, the previously entered Function Number will be shown. If the PROGRAM/DISPLAY Key is pressed while Function Number is displayed, the Set Frequency will be shown. When more than one display function is enabled, the PROGRAM/DISPLAY Key is used to toggle between displays, as shown in Figure 22, on page 19. 5. To change the Keypad for Potentiometer Operation, set Function 2.00 to "0001".

**FIGURE 3**  
MODEL KBDA-24D DRIVE LAYOUT

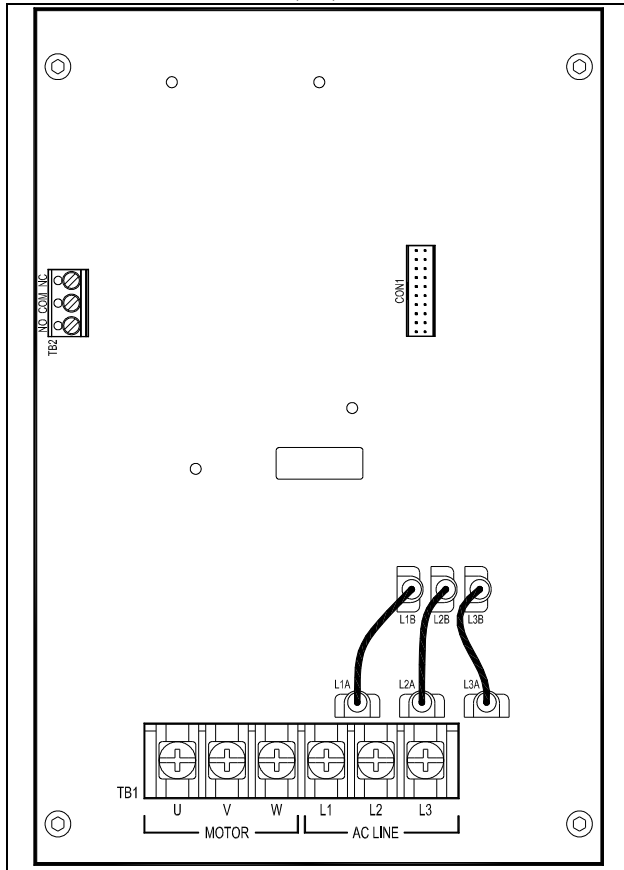


**FIGURE 4**  
MODEL KBDA-24D DRIVE LAYOUT

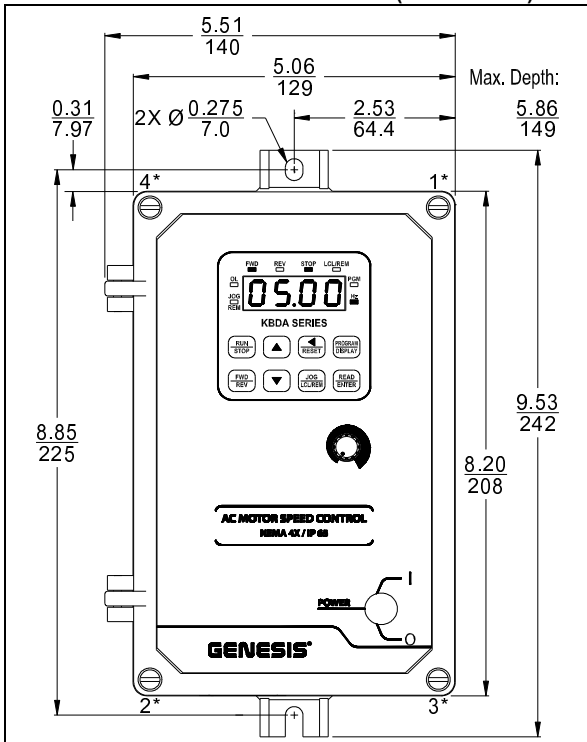


# Preliminary KBDA Series Drives Installation and Operation Manual

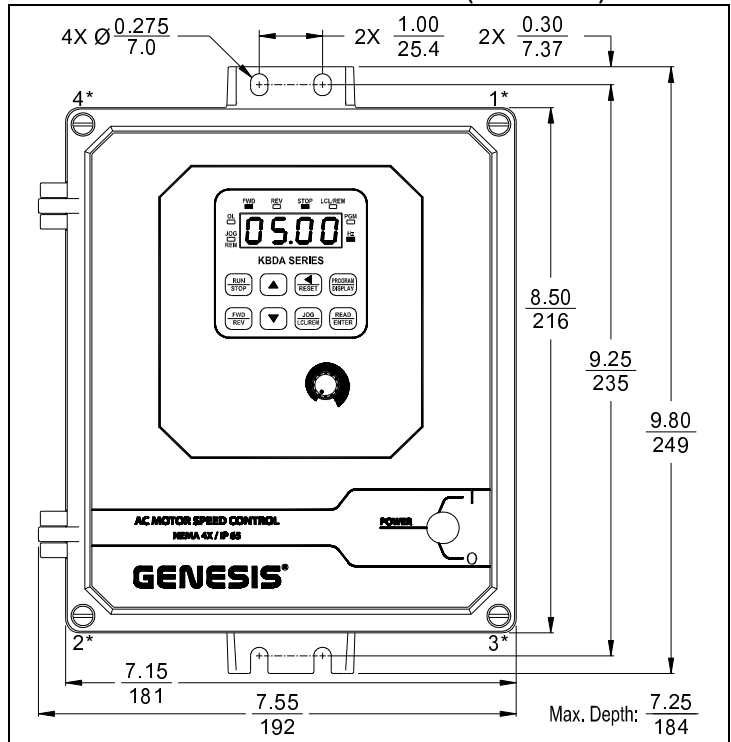
**FIGURE 5**  
MODELS KBDA-29, 45, 48 DRIVE LAYOUT



**FIGURE 6**  
MODEL KBDA-24D  
MECHANICAL SPECIFICATIONS (INCHES/mm)



**FIGURE 7**  
MODELS KBDA-27D, 29, 45, 48  
MECHANICAL SPECIFICATIONS (INCHES/mm)



Model KBDA-24D contains two holes for standard 1/2" liquidtight fittings (will contain three holes for standard 1/2" liquidtight fittings approximately 1<sup>st</sup> Qtr. 2008). Models KBDA-27D, 29, 45, 48 contain two holes for standard 1/2" liquidtight fittings and one hole for standard 3/4" liquidtight fitting. The recommended mounting screw size is 1/4" (M6). \*Tighten the four enclosure cover screws, in the sequence shown, to 12 in-lbs (14 kg-cm).



# Preliminary KBDA Series Drives Installation and Operation Manual

## 4 IMPORTANT APPLICATION INFORMATION

**4.1 MOTOR WITH EXTERNAL FAN COOLING:** Most totally enclosed fan-cooled (TEFC) and open ventilated 3-phase AC induction motors will overheat if used beyond a limited speed range at full torque. Therefore, it is necessary to reduce motor load as speed is decreased.

*Note: Some fan-cooled motors can be used over a wider speed range. Consult the motor manufacturer for details.*

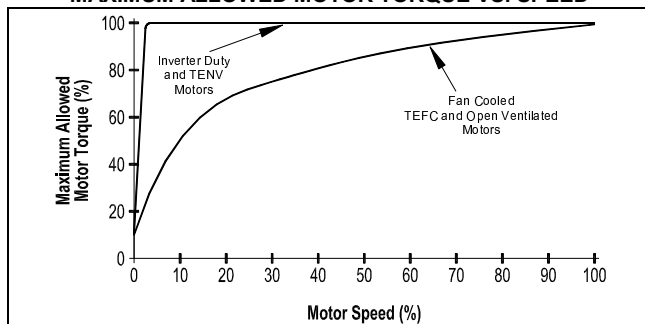
**⚠ WARNING!** Some motors have low speed characteristics, which cause overheating and winding failure under light load or no load conditions. If the motor is operated in this manner for an extended period of time, it is recommended that the unloaded motor current be checked from 2 – 15 Hz (60 – 450 RPM) to ensure motor current does not exceed the nameplate rating. If the motor current exceeds the nameplate rating, the Boost value may have to be decreased (see Function 3.11). **Do not use motor if the motor current exceeds the nameplate rating.**

**⚠ It is recommended that the drive be used with Inverter Duty or TENV motors.**

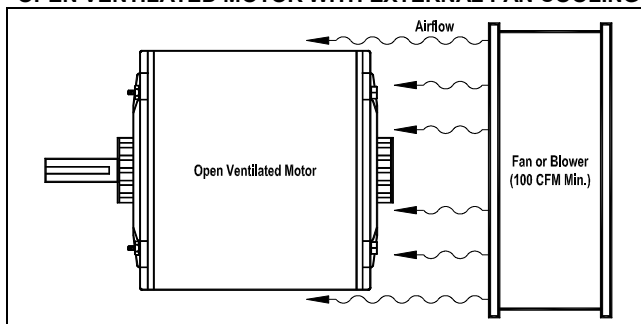
Inverter duty and most totally enclosed non-ventilated (TENV) motors can provide full rated torque over an extended speed range without overheating. See Figure 8.

If external fan cooling is provided, open ventilated motors can also achieve an extended speed range at full rated torque. A box fan or blower with a minimum of 100 CFM per HP is recommended. Mount the fan or blower so the motor is surrounded by the airflow. See Figure 9.

**FIGURE 8**  
MAXIMUM ALLOWED MOTOR TORQUE VS. SPEED



**FIGURE 9**  
OPEN VENTILATED MOTOR WITH EXTERNAL FAN COOLING



**4.2 ELECTRONIC MOTOR OVERLOAD PROTECTION:** The drive contains Modified  $I^2t$  Overload Protection.\* Part of this function consists of a Current Limit (CL) circuit, which limits the drive current to a preset level of 160% of the Motor Nameplate Rated Current setting. **The factory setting for motor nameplate current is the drive rated current, which must be set to the actual motor nameplate current (see Important Application Information (Item 2), on page 3). See Table 3, on page 6. Also see Function 0.01, on page 19.**

Standard  $I^2t$  is undesirable because it causes nuisance tripping. It allows a very high motor current to develop and will turn the drive off after a short period of time. KB's RMS Current Limit Circuit avoids this nuisance tripping while providing maximum motor protection.

If the motor is overloaded to 120% of the Motor Nameplate Rated Current setting (see Function 0.01, on page 19), the  $I^2t$  Timer starts. If the motor continues to be overloaded at the 120% level, the timer will shut down the drive after 30 minutes. If the motor is overloaded to 160% of full load, the drive will trip in 6 seconds.

*\*UL approved as an overload protector for motors.*

## 5 MOUNTING INSTRUCTIONS

It is recommended that the drive be mounted vertically on a flat surface with adequate ventilation. Leave enough room below the drive to allow for AC line, motor connections, and any other connections that are required. Although the drive is designed for outdoor and washdown use, care should be taken to avoid extreme hazardous locations where physical damage can occur. When mounting the drive in an enclosure, the enclosure should be large enough to allow for proper heat dissipation so that the ambient temperature does not exceed 45°C (113 °F) at full rating. The recommended mounting screw size is ¼ inch (M6). See Figures 6 and 7, on page 8.

**⚠ WARNING!** Do not use this drive in an explosion-proof application. Be sure the drive is securely mounted.

# Preliminary KBDA Series Drives Installation and Operation Manual

## 6 ELECTRICAL CONNECTIONS



**WARNING!** Read Safety Warning, on page 4, before using the drive. Disconnect main power before making connections to the drive. To avoid electric shock, be sure to properly ground the drive.

**Application Note:** To avoid erratic operation, do not bundle the AC line and motor wires with each other or with wires from signal following, start/stop contacts, or any other signal wires. Also, do not bundle motor wires from multiple drives in the same conduit. Use shielded cables on all signal wires over 12" (30 cm). The shield should be earth grounded on the drive side only. Connect the drive in accordance with the National Electrical Code requirements and other local codes that may apply.

Be sure to properly fuse each AC line conductor that is not at ground potential. Do not fuse neutral or grounded conductors. A separate AC line switch or contactor must be installed as a disconnect so that each ungrounded conductor is opened. For fuse or circuit breaker selection, see Table 3, on page 6. Also see Section 6.1, on pages 10 and 11.

To maintain the watertight integrity of the drive, be sure to use suitable liquidtight fittings and wires that are appropriate for the application. Model KBDA-24D\* contains two mounting holes for standard 1/2" liquidtight fittings (not supplied) (one liquidtight plug is provided, if only one knockout is used). Models KBDA-27D, 29, 45, 48 contain two mounting holes for standard 1/2" liquidtight fittings (not supplied) and one mounting hole for standard 3/4" liquidtight fitting (not supplied) (two liquidtight plugs are provided, if only one knockout is used). The Liquidtight Fittings Kit (Part No. 9526) is available for all models (see Table 1, on page 6).

The drive is designed with a hinged case so that, when the front cover is open, all wires stay intact. To open the cover, the four screws must be loosened so they are no longer engaged in the case bottom. After mounting the drive and all electrical connections are complete, close the cover making sure that the wires do not get caught or crimped as the cover is closed. Tighten the four screws so that the gasket is slightly compressed. The recommended tightening torque is 12 in-lbs (14 kg-cm). See Figures 6 and 7, on page 8, for the tightening sequence. Do not overtighten.

*\*Model KBDA will contain three holes for standard 1/2" liquidtight fittings approximately 1<sup>st</sup> Qtr. 2008 (two liquidtight plugs are provided, if only one knockout is used).*

**TABLE 4  
DRIVE TERMINAL BLOCK WIRE AND TIGHTENING TORQUE SPECIFICATIONS**

Terminal Block	Description	Model	Maximum Wire Size (Cu)		Recommended Tightening Torque	
			AWG	mm <sup>2</sup>	in-lbs	kg-cm
TB1	AC Line Input and Motor Connections	KBDA-24D	12	3.3	7	8
		KBDA-27D, 29, 45, 48	12	3.3	12	14
TB2	Run/Fault Output Relay Contacts	All	16	1.3	3.5	4

**6.1 AC LINE INPUT CONNECTION:** Connect the AC line input to Terminal Block TB1. See Electrical Ratings, Table 3, on page 6.

**Application Note:** If operation with a Ground-Fault Circuit-Interrupter (GFCI) is required, see Function 0.04, on page 19.

**Note:** The rated AC line voltage of the drive must match the actual AC line input voltage. On Models KBDA-24D, 27D, the setting of Jumper J1 must match the AC line input voltage.

**Model KBDA-24D:** Terminals "L1", "L2" – Designed for single-phase AC line input only. Rated for 208/230 Volt AC line input with Jumper J1 set to the "230V" position (factory setting) and rated for 115 Volt AC line input with Jumper J1 set to the "115V" position. See Figure 10, on page 11.

**Note:** 230 Volts AC will be applied to the motor with 115 Volt AC line input.

**Model KBDA-27D:** Terminals "L1", "L2" – Designed for single-phase AC line input only. Rated for 208/230 Volt AC line input with Jumper J1 set to the "230V" position (factory setting) and rated for 115 Volt AC line input with Jumper J1 set to the "115V" position. Rated for 1 1/2 HP maximum with 115 Volt AC line input and 2 HP maximum with 208/230 Volt AC line input. See Figure 10, on page 11.

**Note:** 230 Volts AC will be applied to the motor with 115 Volt AC line input.

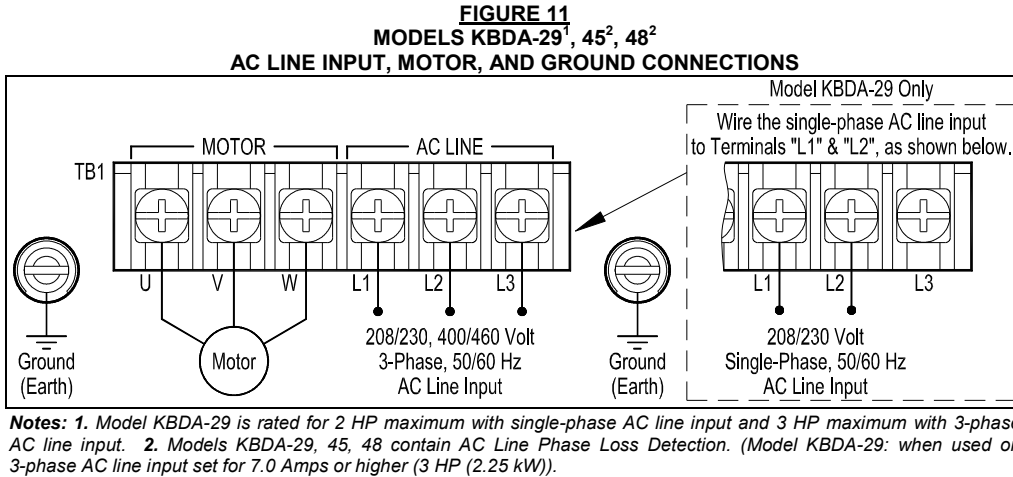
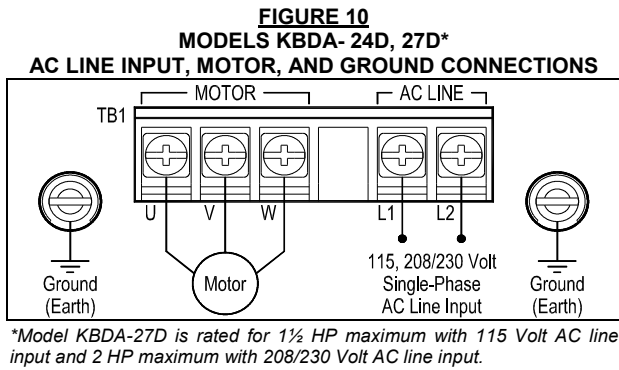
**Model KBDA-29:** Terminals "L1", "L2", "L3" – Designed for single-phase or 3-phase AC line input. Rated for 208/230 Volt AC line input only. Rated 2 HP maximum with single-phase AC line input (Terminals "L1", "L2") and 3 HP maximum with 3-phase AC line input (Terminals "L1", "L2", "L3"). See Figure 11, on page 11.

**Models KBDA-45, 48:** Terminals "L1", "L2", "L3" – Designed for 3-phase AC line input only. Rated for 400/460 Volt AC line input only. See Figure 11, on page 11.

**AC Line Fusing:** The drive does not contain line fuses. Most electrical codes require that each ungrounded conductor contain circuit protection. **Do not fuse neutral or ground connections.** It is recommended to install a fuse (Littelfuse 326, Buss ABC, or equivalent) or a circuit breaker (Square D QUO or equivalent) in series with each ungrounded conductor. **Do not fuse motor leads.** For the recommended fuse size, see Table 3, on page 6.

Connect the drive in accordance with the National Electrical Code requirements and other local codes that may apply to the application.

# Preliminary KBDA Series Drives Installation and Operation Manual



**6.2 GROUND CONNECTION:** Connect the ground wire (earth) to any available Green Ground Screw. The Ground Screws are located near Terminal Block TB1. Be sure the motor is also properly grounded. See Figures 10 and 11, above.

**6.3 MOTOR CONNECTION:** Connect the motor to Terminal Block TB1 Terminals "U", "V", "W". See Figures 10 and 11, above. Be sure the motor is properly grounded. Motor cable length should not exceed 100 ft. (30 m) – special reactors may be required – consult our Sales Department. Be sure Function 0.01 is set to the corresponding Motor Nameplate Current.

**Note:** If the motor does not rotate in the desired direction, either: 1. Reverse any two motor leads (with AC line disconnected and motor stopped). or 2. Use the FWD/REV Key. or 3. Use Function 1.02 to reprogram the forward and reverse direction.

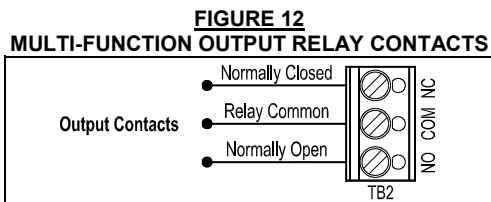
**6.4 MULTI-FUNCTION OUTPUT RELAY CONNECTION:** The Multi-Function Output Relay Contacts are located at TB2, as shown in Figure 12. The Multi-Function Output Relay is factory programmed to function as a "Run" relay (Function 5.00 set to "0000"). When the drive is put into the Run Mode, the relay contacts will change state (the Normally Open (N.O.) contact will close and the Normally Closed (N.C.) contact will open). See Table 5.

When the Multi-Function Output Relay is programmed to function as a "Fault" relay (Function 5.00 set to "0001") and a fault occurs while the drive is in the Run Mode, the relay contacts will change state. The Normally Open (N.O.) contact (closed in the Run Mode) will open and the Normally Closed (N.C.) contact (open in the Run Mode) will close. See Table 5.

The Multi-Function Output Relay can also be programmed for the following functions, as shown in the Programmable Function Summary List (Section 10), on pages 19 – 23 (and described in the *KBDA Programmable Function List (Detailed)* (Part No. AXXXXX)): Target Frequency, Frequency Threshold, I<sup>2</sup>t or I•t Fault Mode, and Load Loss.

**TABLE 5**  
**"RUN" & "FAULT" RELAY OPERATING MODES**

Drive Operating Condition	Function 5.00 Set to "0000"		Function 5.00 Set to "0001"	
	"Run" Relay Mode		"Fault" Relay Mode	
	N.O. Contact	N.C. Contact	N.O. Contact	N.C. Contact
Power Off	Open	Closed	Open	Closed
Power On (Stop Mode)	Open	Closed	Closed	Open
Run Mode	Closed	Open	Closed	Open
All Faults	Open	Closed	Open	Closed



# Preliminary KBDA Series Drives Installation and Operation Manual

**6.5 REMOTE OPERATIONS WHICH REQUIRE THE OPTIONAL IODA (PART NO. 9668) (See Appendix A, on pages 25 – 28)**  
 Multi-Function Input Terminals, Main Speed Potentiometer (5 kΩ), 2-Wire and 3-Wire Start/Stop, Signal Following, Up/Down Frequency Control, Signal Isolation, Isolated Output Voltage (for controlling auxiliary devices), Open Collector Outputs, and Multi-Function Output Relay Contacts.

## 7 AC LINE INPUT VOLTAGE SELECTION (JUMPER J1 (MODELS KBDA-24D, 27D ONLY))



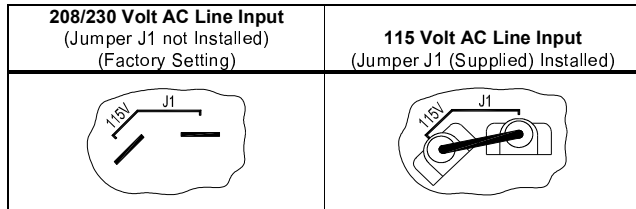
Do not connect the AC line input until Jumper J1 is set for the proper input voltage being applied to the drive.

**Model KBDA-24D:** Jumper J1 is not installed for 208/230 Volt AC line input (factory setting). For 115 Volt AC line input, install Jumper J1 (supplied). See Figure 13.

**Model KBDA-27D:** Jumper J1 is factory installed on Terminal "230V" for 208/230 Volt AC line input. For 115 Volt AC line input, the jumper must be removed and installed on Terminal "115V". See Figure 14.

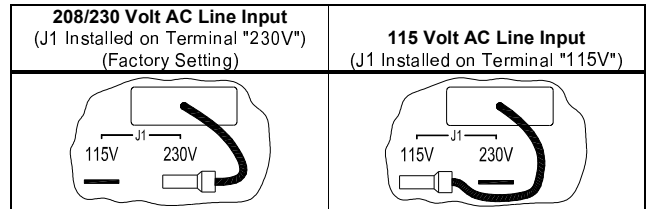
**FIGURE 13**

### MODEL KBDA-24D AC LINE INPUT VOLTAGE SELECTION



**FIGURE 14**

### MODEL KBDA-27D AC LINE INPUT VOLTAGE SELECTION



## 8 RECOMMENDED HIGH VOLTAGE DIELECTRIC WITHSTAND TESTING (HI-POT TESTING)

Testing agencies such as UL, CSA, VDE, etc., usually require that equipment undergo a hi-pot test. In order to prevent catastrophic damage to the drive, which has been installed in the equipment, the following procedure is recommended. A typical hi-pot test setup is shown in Figure 15. **All drives have been factory hi-pot tested in accordance with UL requirements.**



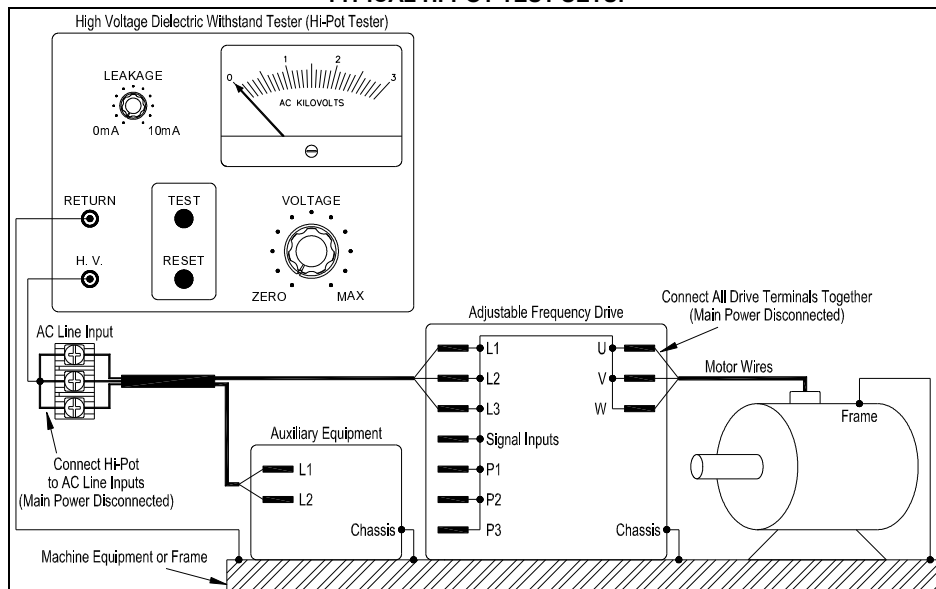
**WARNING!** All equipment AC line inputs must be disconnected from the AC power.

- 8.1 Connect all equipment AC power input lines together and connect them to the H.V. lead of the hi-pot tester. Connect the RETURN lead of the hi-pot tester to the frame on which the drive and other auxiliary equipment are mounted.
- 8.2 The hi-pot tester must have an automatic ramp-up to the test voltage and an automatic ramp-down to zero voltage.

**Note:** If the hi-pot tester does not have automatic ramping, then the hi-pot output must be manually increased to the test voltage and then manually reduced to zero. This procedure must be followed for each machine to be tested. A suggested hi-pot tester is Slaughter Model 2550.

**CAUTION!** Instantly applying the hi-pot voltage will cause irreversible damage to the drive, which will void the warranty.

**FIGURE 15  
TYPICAL HI-POT TEST SETUP**



# Preliminary KBDA Series Drives Installation and Operation Manual

## 9 DRIVE OPERATION

Before operating the drive, read Section 9.2, on page 13, for instructions on the Digital Keypad Operation. See Figure 2, on page 6, for the keypad layout.

The 4-digit display can indicate various functions of the drive: Set Frequency, Motor RPM, Output Current and Voltage, Custom Units, Function Numbers, Function Codes or Values, and Fault Codes. See Section 9.4, on page 17.

See Section 9.3, on pages 13 – 17, for information on programming the drive. If an error message appears while programming the drive, see Section 9.5, on page 18.

**9.1 START-UP PROCEDURE:** After the drive has been properly setup and all connections completed, the start-up procedure can begin. If the AC power has been properly brought to the drive, the LEDs will indicate the drive's status, as described in Section 11, on page 24. See Section 9.4, on page 17, for the Digital Readout Codes.

To start the drive, press the Start Key. The motor will begin to accelerate to the Set Frequency. The factory set frequency is 0.500 Hz.

**9.2 KEYPAD DESCRIPTION:** The Keypad has eight (8) keys which are used to program drive functions, as described in Table 6. The eight (8) LEDs provide indication of the drive's operational status, as described in Section 11, on page 24. A Main Speed Potentiometer is also provided to set the Drive Frequency (Function 2.00 set to "0001"). See Figure 2, on page 7.

*Note: To avoid damage, never operate the keypad with a screwdriver or other sharp-ended tool.*

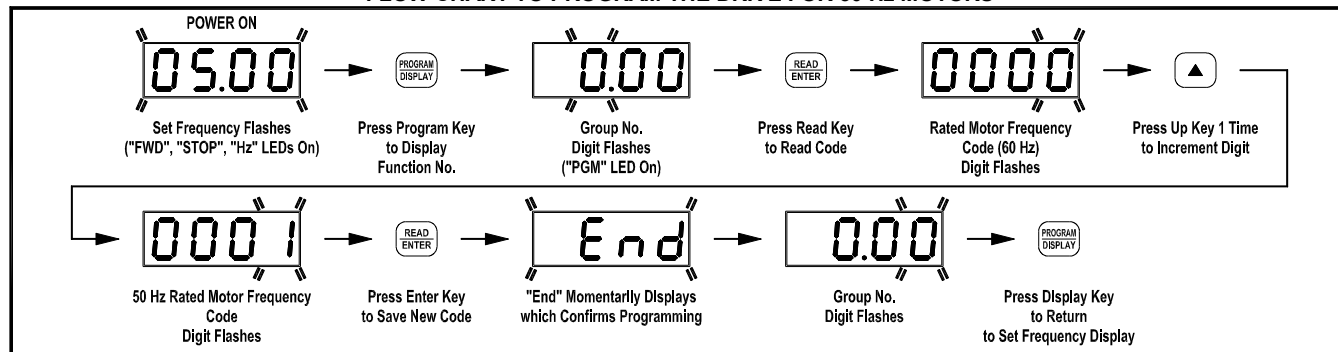
**TABLE 6  
KEYPAD DESCRIPTION**

Key	Description
	Starts or stops the drive.
	Changes motor direction.
	Up Key: Increases Output Frequency, Set Frequency, Function Number Value, and Code setting.
	Down Key: Decreases Output Frequency, Set Frequency, Function Number Value, and Code setting.
	Factory programmed to function as a Jog Key. When the key is pressed, it toggles between Run Mode and Jog Mode (the "JOG/REM" LED will illuminate and the display will show the Jog Frequency Setting (see Function 3.13)). If the key is reprogrammed for Local/Remote Operation (see Function 2.02), the key is used to toggle between Local (Keypad) or Remote Signal Operation (the "LCL/REM" LED will illuminate).* <i>*Optional IODA or Modbus is required for Local/Remote Operation.</i>
	Used to enter Program Mode and Display Mode. If the key is pressed while Set Frequency is displayed, the previously entered Function Number will be shown. If the key is pressed while Function Number is displayed, the Set Frequency will be shown. When more than one display function is enabled, the key is used to toggle between displays. See Figure 22, on page 17.
	Left Shift / Reset Key: Moves the changeable digit; Resets the drive to clear a fault.
	Reads or Enters a Function Number's Value or Code setting. The key is also used to read or enter the frequency setting.

**9.3 FLOW CHARTS FOR IMPORTANT PROGRAMMING FUNCTIONS:** See Figures 16 – 22, on pages 13 – 17, for flow charts to program important functions. The flow charts also serve as a guide to understand the programming procedure.

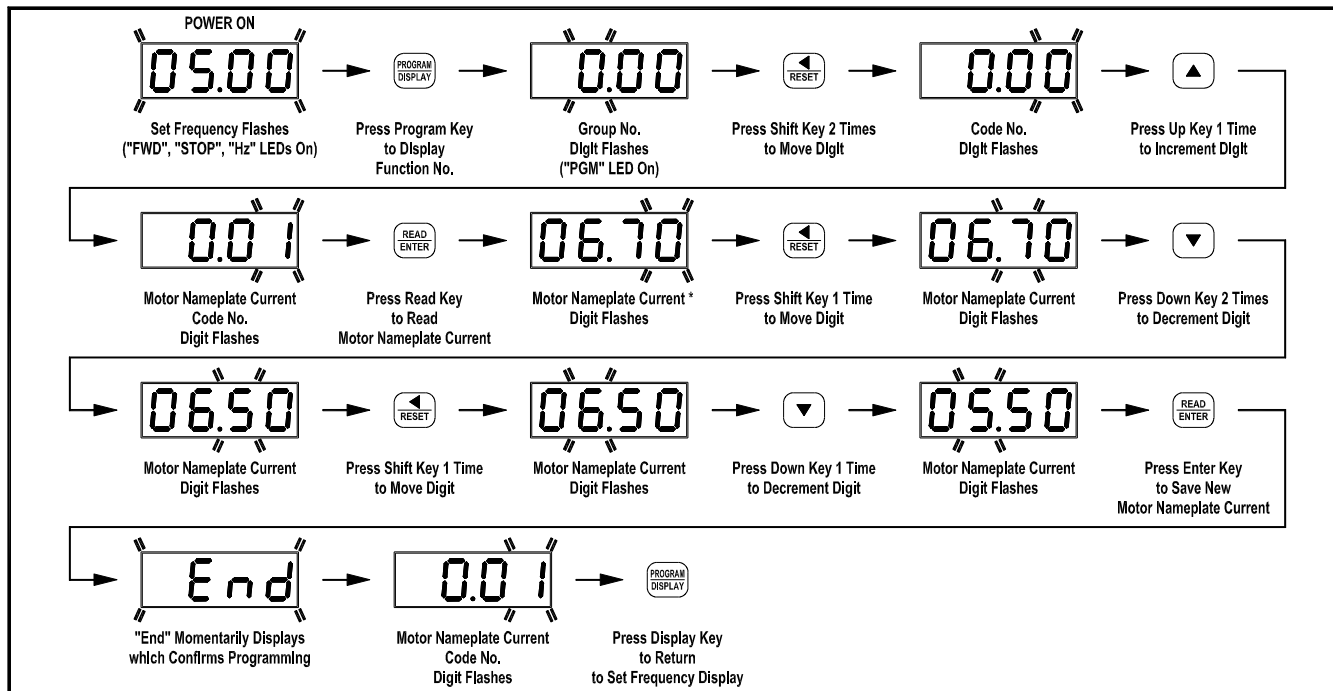
*Note: See Table 7, on page 17, for a description of the Digital Readout Codes.*

**FIGURE 16  
FLOW CHART TO PROGRAM THE DRIVE FOR 50 Hz MOTORS**



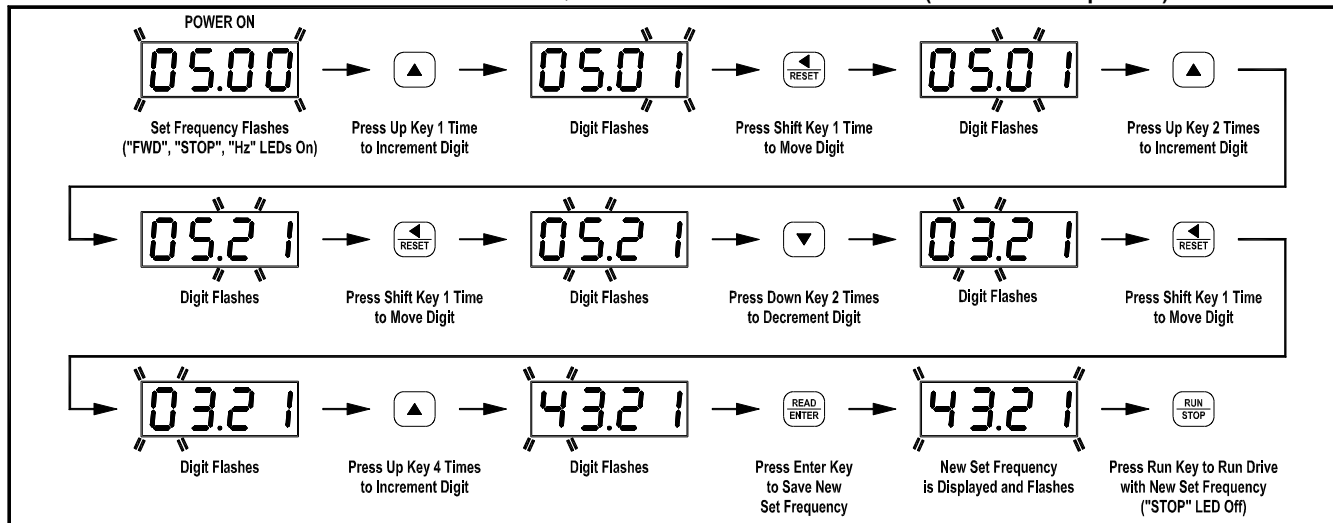
# Preliminary KBDA Series Drives Installation and Operation Manual

**FIGURE 17**  
FLOW CHART TO PROGRAM MOTOR CURRENT FROM 6.7 AMPS TO 5.5 AMPS



\*For Models KBDA-27D, 29, the factory setting of Function 0.01 (Motor Nameplate Current) is 6.7 Amps. See Table 3, on page 6, for the factory setting of Function 0.01 for all other models.

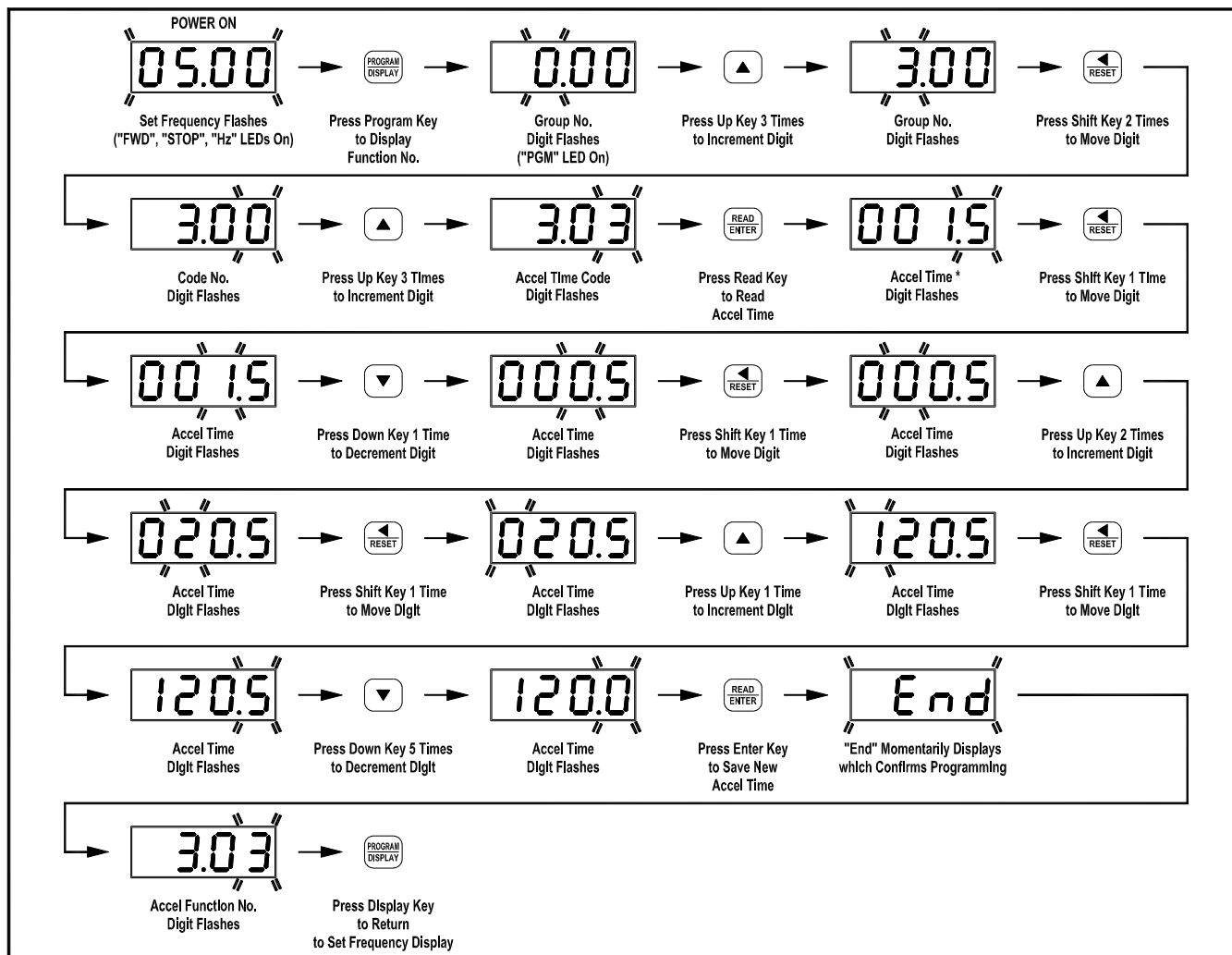
**FIGURE 18**  
FLOW CHART TO CHANGE SET FREQUENCY FROM 5.00 Hz TO 43.21 Hz (Drive in the Stop Mode)\*



\*If Function 2.01 is set to "0000", frequency change requires "ENTER". Throughout this sequence you must proceed to the next step within 20 seconds, before the "Press Enter Key" step, or the display will revert to "05.00". The new value will be stored in Function 3.00.

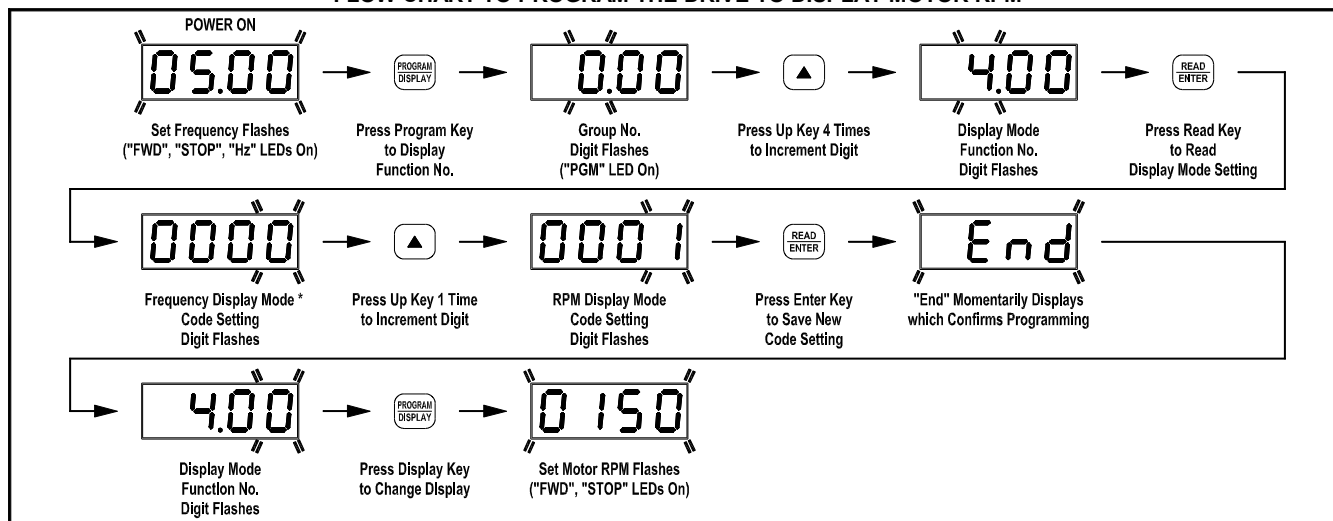
# Preliminary KBDA Series Drives Installation and Operation Manual

**FIGURE 19**  
FLOW CHART TO PROGRAM ACCEL TIME VALUE FROM 1.5 SECONDS TO 120 SECONDS



\*The factory setting of Function 3.03 (Accel Time) is "1.5" seconds. The minimum setting of Accel is 0.1 seconds, therefore, the left digits must be changed first since an Accel setting of 000.0 is not allowed.

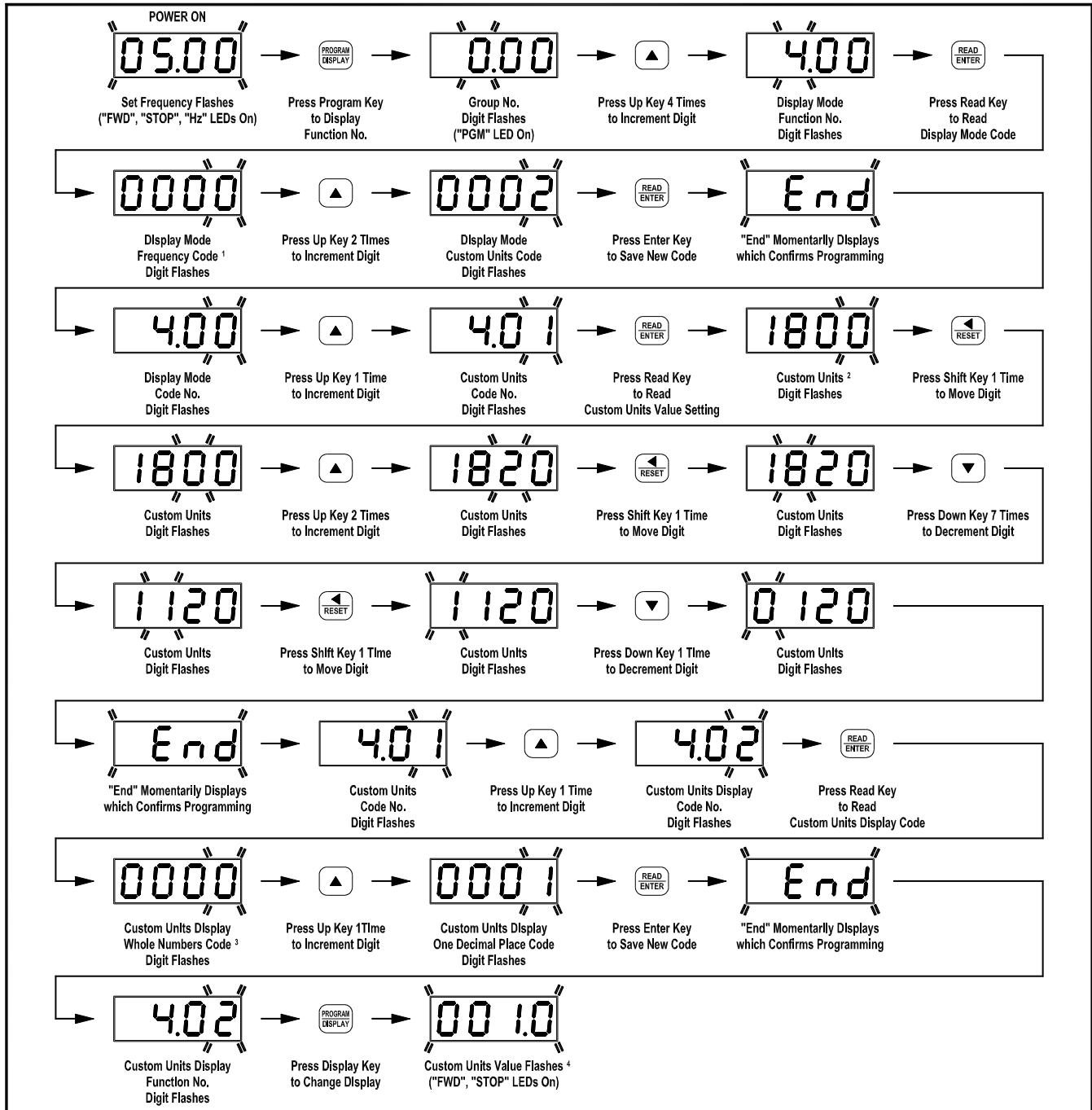
**FIGURE 20**  
FLOW CHART TO PROGRAM THE DRIVE TO DISPLAY MOTOR RPM



\*The factory setting of Function 4.00 (Display Mode) is "0000" (Frequency).

# Preliminary KBDA Series Drives Installation and Operation Manual

**FIGURE 21**  
**FLOW CHART TO PROGRAM THE DRIVE TO DISPLAY CUSTOM UNITS "012.0"**



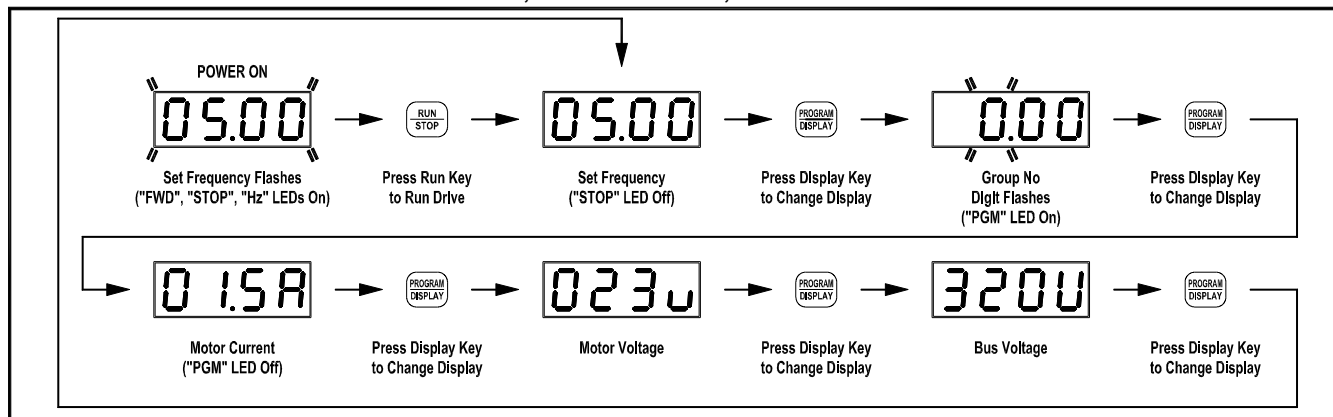
**Notes:** 1. The factory setting of Function 4.00 (Display Mode) is "0000" (Frequency). 2. The factory setting of Function 4.01 (Custom Units Value) is "1800". 3. The factory setting of Function 4.02 (Custom Units Display) is "0000" (Whole Numbers). 4. The Custom Unit setting "012.0" will be displayed at full speed.



# Preliminary KBDA Series Drives Installation and Operation Manual

FIGURE 22

FLOW CHART SHOWING MOTOR CURRENT, MOTOR VOLTAGE, AND BUS VOLTAGE ADDED TO THE BASIC DISPLAY\*



\*Functions 4.04 – 4.06 set to "0001".

9.4 **4-DIGIT DISPLAY:** The 4-digit display provides readout of drive status, operating parameters, and faults. See Table 7 for the Digital Readout Codes displayed and their descriptions.



**WARNING!** Do not depend on the LEDs or the 4-Digit Display to no longer be illuminated as a guaranteed power off condition. Be sure the main power switch or circuit breaker is in the "OFF" position before servicing the drive.

TABLE 7  
DIGITAL READOUT CODES

Display	Description	Display	Description
StOp	<b>Drive Stopped:</b> Indicates that the drive is in the Stop Mode. Function 4.03 set to "0001".	End	<b>Parameter Changed:</b> Momentarily flashes. Indicates that a parameter has been successfully changed.
8.01	<b>Function No. Example:</b> A Function No. consists of a Group No. (digits on the left side of the decimal point) and a Group Code No. (digits on the right side of the decimal point).	-. -A	<b>Motor Current Display:</b> When the display is set to show Motor Current, the format will be "XX.XA". Function 4.04 set to "0001".
- - -U	<b>Motor Voltage Display:</b> When the display is set to show Motor Voltage, the format will be "XXU". Function 4.05 set to "0001".	- - -U	<b>Bus Voltage Display:</b> When the display is set to show Bus Voltage, the format will be "XXXU". Function 4.06 set to "0001".
-LU-	<b>Low Voltage Trip:</b> Indicates that the AC line input voltage is below the Undervoltage Trip Point specified in Table 2, on page 6.	LU-r	<b>Low Voltage Recovery:</b> Indicates that a Low Voltage Trip occurred and the AC line input voltage has returned to within the operating range specified in Table 2, on page 6.
-OU-	<b>Overvoltage Trip:</b> Indicates that the AC line input voltage is above the Overvoltage Trip Point specified in Table 2, on page 6.	OU-r	<b>Overvoltage Recovery:</b> Indicates that an Overvoltage Trip occurred and the AC line input voltage has returned to within the operating range specified in Table 2, on page 6.
OL-t	<b>Overload Trip (I<sup>2</sup>t Timeout):</b> Indicates that the motor has been overloaded for an extended period of time.	EF-t	<b>External Fault Trip:</b> Indicates that an external fault has occurred at one of the MFITs of the IODA. Functions 7.00 – 7.06 set to "0008".
CS-t	<b>Current Source Trip:</b> Indicates that the current signal output (from the IODA) has been opened.	-SC-	<b>Short Circuit Fault:</b> Indicates that the drive detected a short circuit at the motor (phase-to-phase).
-PL-	<b>AC Line Phase Loss Detection:</b> Indicates that the drive has detected a loss of one of the phases in the 3-phase AC line input applied to Models KBDA-29*, 45, 48.	Err1	<b>Data Enter Error:</b> Indicates that the drive is in the Program Mode and a non-valid parameter change has been attempted.
Err2	<b>Keypad Communication Error:</b> Indicates that the keypad failed to initialize when the drive is powered up. This is an abnormal condition – contact our Sales Department.	Err3	<b>Flash Memory Error:</b> Indicates that a flash memory error on the drive has occurred. This is an abnormal condition – contact our Sales Department.
Err4	<b>IODA Error:</b> Indicates that the drive has lost communication with the IODA.		

\*Model KBDA-29: when used on 3-phase AC line input set for 7.0 Amps or higher (3 HP (2.25 kW)).

# Preliminary KBDA Series Drives Installation and Operation Manual

**9.5 FAULT RECOVERY:** The drive monitors many faults. See Function 1.05, on page 21, for restarting the drive after a fault has been cleared. See Section 9.4, on page 17, for the 4-digit Display Readout codes and Section 11, on page 24, for description of the Status LEDs. See Appendix A, on pages 25, for IODA faults.

**Drive Faults:** Undervoltage ("–LU–"), Overvoltage ("–OU–"), Short Circuit at the motor (phase-to-phase) ("–SC–"), I<sup>2</sup>t or I•t Fault ("OL–t"), and Phase Loss Detection (Models KBDA-29\*, 45, 48 only) ("–PL–").

*\*When used on 3-phase AC line input set for 7.0 Amps or higher (3 HP (2.25 kW)).*

## 10 PROGRAMMABLE FUNCTION SUMMARY LIST

All functions have been factory set, as shown in the following tables.

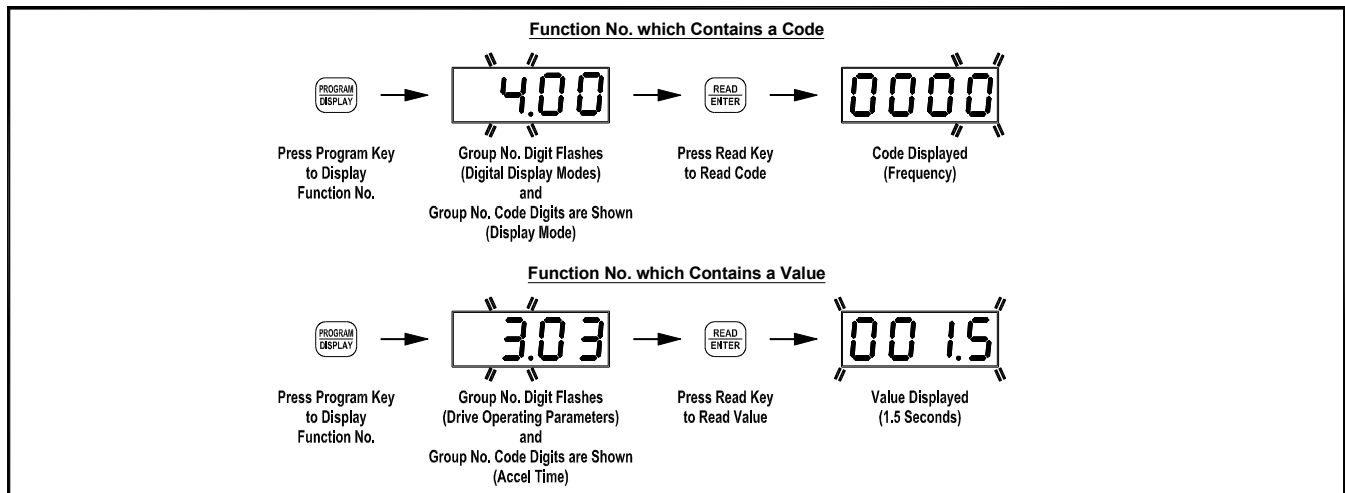
**Programming Mode:** When the drive is put into the Programming Mode (see Figure 23), a Function No. will be displayed. A Function No. consists of a Group No. (digits on the left side of the decimal point) and a Group No. Code (digits on the right side of the decimal point). The digits are can be changed using the Up and Down Keys. The Left Shift Key is used to move the changeable digit.

When the READ Key is pressed, either a Code or Value will be displayed. Codes have specific descriptions. Values have numeric ranges.

**Application Note:** The programming of the drive can be performed without a motor connected. On drives with 3-phase AC line input requirements, the programming can be performed with single-phase AC line input. The drive's Phase Loss Detection will not trip the drive without the motor connected.

To program multiple drives, the optional DownLoad Module™ (Part No. 9582) can be used to upload the drive program and facilitate downloading it to other drives.

**FIGURE 23  
FUNCTION NO. DESCRIPTION**



**TABLE 8  
MODEL SOFTWARE REVISION CODES (Rev. 100.1)**

The Programmable Function List, on Pages 19 – 23, is Applicable to the Following\* Software Revision Codes

Model No.	Software Revision Code
KBDA-24D	29/1.01
KBDA-27D	35/1.01
KBDA-29	37/1.00
KBDA-45	38/1.00
KBDA-48	39/1.00

*\*Or higher.*

# Preliminary KBDA Series Drives Installation and Operation Manual

## PROGRAMMABLE FUNCTION SUMMARY LIST (REV. 100.1)

### PROGRAMMABLE FUNCTION GROUPS

Function Group No.	Description	Function Group No.	Description
0	Motor and Drive Parameters	6	Drive Status and Reset
1	Run/Stop Mode	7	Multi-Function Input Terminals <sup>(1)</sup>
2	Frequency Control	8	Multi-Function Output Relays and Output Signal Operation <sup>(1)</sup>
3	Drive Operating Parameters	9	Analog Input Signal Operation <sup>(1)</sup>
4	Digital Display Modes	10	Communication Mode <sup>(2)</sup>
5	Onboard Multi-Function Output Relay Operating Mode	11	Reserved Functions

*Note: (1) IODA Option Board required. (2) DIAC Option Board required.*

### FUNCTION GROUP 0 – MOTOR AND DRIVE PARAMETERS

Function No.	Description	Range/Code	Factory Setting
0.00 *	Rated Motor Frequency (Hz)	0000: 60 Hz 0001: 50 Hz 0002: Special (Set by Function 0.05)	0000
0.01 *	Motor Nameplate Current (Amps)	—	<sup>(1)</sup>
0.02 *	Motor Type	0000: Inverter Duty, TEFC 0001: External Fan Cooled	0000
0.03 *	Torque Mode	0000: Constant Torque (Machinery) 0001: Variable Torque (HVAC)	0000
0.04 *	GFCI Operation <sup>(2)</sup>	0000: GFCI Operation Disabled 0001: GFCI Operation with Standard GFCI 0002: GFCI Operation with Sensitive GFCI	0000
0.05 *	Motor Frequency (Hz) <sup>(3),(4)</sup>	30 – 240	60, 50
0.06 *	Motor Nameplate Voltage (% Drive Output) <sup>(5)</sup>	0 – 100.0	100 <sup>(6)</sup>

**Notes:** (1) Factory Setting is the drive rated output current. See Table 3, on page 6. This function is used to enter the Motor Nameplate Rated Current, which allows proper operation of the I<sup>2</sup>t Motor Overload Protection. (2) GFCI operation overrides the Switching Frequency set by Function 3.15. (3) When the drive is set for 50 Hz motors (Function 0.00 set to "0001"), the Motor Frequency factory setting will automatically reset to 50 Hz. (4) The Motor Frequency for standard 50 Hz or 60 Hz motors is set by Function 0.00. For custom motors (e.g., 100 Hz) set Function 0.00 to "0002" and Function 0.05 to the Motor Nameplate Rated Frequency. (5) This function is used for motors with non-standard nameplate rated voltage (e.g., 80 Volts AC). (6) The factory set output of the drive is 100% of the AC line input voltage. In 60 Hz Mode (Function 0.00 set to "0000") the drive output will be 230 Volts, maximum, for 230 Volt motors. In 50 Hz Mode (Function 0.00 set to "0001") the drive output will be 220 Volts, maximum, for 220 Volt motors.

\*Functions which can only be changed while the drive is in the Stop Mode.

### FUNCTION GROUP 1 – RUN/STOP MODE

Function No.	Description	Range/Code	Factory Setting
1.00 *	Run/Stop-Forward/Reverse Control	0000: Keypad 0001: External Contacts <sup>(1)</sup> 0002: Communication <sup>(2)</sup>	0000
1.01 *	Forward/Reverse Control	0000: Instant Reverse 0001: Stop Command Must be Given Prior to Reverse Command 0002: Reverse Command Disabled 0003: Forward Command Disabled	0000
1.02 *	Motor Direction	0000: Forward 0001: Reverse	0000
1.03 *	Start Command	0000: Accelerates to Last Set Frequency 0001: Accelerates to Lower Frequency Limit (See Function 3.01)	0000
1.04 *	Start Mode	0000: Spin Start 0001: Stop Before Restart	0000
1.05 *	Auto/Manual Start Mode	0000: Manual Start Mode 0001: Manual Start with Ride-Through (Set by Function 1.06) 0002: Auto Start After Undervoltage Fault Clears 0003: Auto Start All Faults (Except Short Circuit Fault) <sup>(3)</sup> 0004: Auto Start All Faults (Except I <sup>2</sup> t and Short Circuit Faults)	0000
1.06 *	Ride-Through Time (Seconds)	0.0 – 2.0	0.5
1.07 *	Number of Restart Attempts	0 – 10	3
1.08 *	Start Delay Time (Seconds)	0 – 240	0
1.09 *	Stop Mode	0000: Regenerate-to-Stop 0001: Coast-to-Stop 0002: Regeneration with Injection Brake-to-Stop (Set by Functions 1.11 – 1.14)	0000
1.10 *	Holding Torque in Stop Mode (%)	0 – 10	1
1.11	Injection Brake Start Frequency (Hz)	0.00 – 240.0	0.00
1.12	Injection Brake Level (%)	0 – 30	0
1.13	Injection Brake Time (Seconds)	0.0 – 25.5	0.0

**Notes:** (1) IODA Option Board required. (2) DIAC Option Board required. (3) For Auto Start, Function 1.07 must be set to greater than "0" (factory setting is "2"). (4) Model KBDA-24D only.

\*Functions which can only be changed while the drive is in the Stop Mode.

# Preliminary KBDA Series Drives Installation and Operation Manual

## FUNCTION GROUP 2 – FREQUENCY CONTROL

Function No.	Description	Range/Code	Factory Setting
2.00 *	Frequency Control	0000: Keypad 0001: Built-In Potentiometer 0002: Analog Signal 1 <sup>(1)</sup> 0003: Analog Signal 2 <sup>(1)</sup> 0004: Communication <sup>(2)</sup> 0005: Up/Down Using MFITs <sup>(1)</sup>	0000
2.01 *	Up Key, Down Key Operation Mode	0000: Frequency Change Requires Enter Command 0001: Direct Frequency Change 0002: Keypad Disable	0000
2.02 *	Jog-Local/Remote <sup>(3), (4)</sup>	0000: Jog Enabled 0001: Jog Disabled 0002: Jog Disabled; Local/Remote Enabled <sup>(1)</sup>	0000

**Notes:** (1) IODA Option Board required. (2) DIAC Option Board required. (3) See Function 3.12 (Jog Mode), Function 3.13 (Jog Frequency), and Function 3.14 (Jog Accel/Decel Time). (4) The Jog function can be reprogrammed for Local/Remote (LCL/REM) Operation. When in Remote Mode Operation, the "JOG/REM" LED will flash.

\*Functions which can only be changed while the drive is in the Stop Mode.

## FUNCTION GROUP 3 – DRIVE OPERATING PARAMETERS

Function No.	Description	Range/Code	Factory Setting
3.00	Stored Set Frequency (Hz)	0.00 – 240.0	5.00
3.01	Lower Frequency Limit (Hz)	0.00 – 240.0	0.00
3.02	Upper Frequency Limit (Hz) <sup>(1)</sup>	0.00 – 240.0	60.0, 50.0
3.03	Accel Time (Seconds) <sup>(2)</sup>	0.1 – 180.0	1.5
3.04	Decel Time (Seconds) <sup>(2)</sup>	0.3 – 180.0	1.5
3.05	S-Curve Time Accel (Seconds) <sup>(2)</sup>	0.0 – 30.0	0.0
3.06	S-Curve Time Decel (Seconds) <sup>(2)</sup>	0.0 – 30.0	0.0
3.07 *	Skip Frequency (Hz)	0.00 – 240.0	0.00
3.08 *	Skip Frequency Bandwidth (± Hz)	0.00 – 2.00	0.00
3.09 *	Motor Overload Protection	0000: I <sub>t</sub> with Current Limit Enabled 0001: I <sub>t</sub> with Current Limit Enabled	0000
3.10 *	I <sub>t</sub> with Current Limit Trip Time (Seconds)	1.0 – 20.0	6.0
3.11	Boost Value (%)	0.0 – 28.0	7.0
3.12 *	Jog Mode	0000: Momentary 0001: Latching	0000
3.13	Jog Frequency Set (Hz)	0.00 – 240.0	5.00
3.14	Jog Accel/Decel Time (Seconds)	0.3 – 10.0	1.0
3.15 *	Switching Frequency (kHz)	0000: 8 0001: 10 0002: 12	0000
3.16	Flux Vector Compensation (%)	0.0 – 10.0	5.0

**Notes:** (1) When the drive is set for 50 Hz motors (Function 0.00 set to "0001"), the Upper Frequency Limit factory setting will automatically reset to 50 Hz. (2) Time set for Functions 3.03 and 3.04 must be equal to or greater than the time set for Functions 3.05 and 3.06, respectively.

\*Functions which can only be changed while the drive is in the Stop Mode.

## FUNCTION GROUP 4 – DIGITAL DISPLAY MODES

Function No.	Description	Range/Code	Factory Setting
4.00	Display Mode	0000: Frequency 0001: RPM <sup>(1)</sup> 0002: Custom Units	0000
4.01	Custom Units (Significant Digits)	0 – 9999	100
4.02	Custom Units Display	0000: Whole Numbers 0001: One Decimal Place 0002: Two Decimal Places 0003: Three Decimal Places	0000
4.03	Display in Stop Mode	0000: Displays Last Run Setting 0001: Displays "Stop" when in the Stop Mode 0002: Displays "0000"	0000
4.04	Motor Current Display <sup>(2), (3)</sup>	0000: Disabled 0001: Enabled	0000
4.05	Motor Voltage Display <sup>(2), (3)</sup>	0000: Disabled 0001: Enabled	0000
4.06	Bus Voltage Display <sup>(2), (3)</sup>	0000: Disabled 0001: Enabled	0000

**Notes:** (1) Based on 4-pole motor. (2) The Display Key is used to toggle between displays. See Figure 22, on page 17. (3) If Motor Current Display is enabled, the display will show "XX.XA". If Motor Voltage Display is enabled, the display will show "XXXu". If Bus Voltage Display is enabled, the display will show "XXXU".

# Preliminary KBDA Series Drives Installation and Operation Manual

## FUNCTION GROUP 5 – ONBOARD MULTI-FUNCTION OUTPUT RELAY OPERATING MODE

Function No.	Description	Range/Code	Factory Setting
5.00	Relay Operation Mode	<b>0000:</b> Run <b>0001:</b> Fault <sup>(1)</sup> <b>0002:</b> Target Frequency (Function 5.01 ± Function 5.02) <b>0003:</b> Frequency Threshold Level (> Function 5.01 – Function 5.02) <sup>(2)</sup> <b>0004:</b> Frequency Threshold Level (< Function 5.01 + Function 5.02) <sup>(3)</sup> <b>0005:</b> I <sup>2</sup> t or I-t Fault <b>0006:</b> Load Loss (See Function 5.03)	0000
5.01	Frequency Reached (Hz)	<b>0.00 – 240.0</b>	0.00
5.02	Frequency Bandwidth (Hz)	<b>0.00 – 30.00</b>	1.00
5.03	Load Loss Threshold <sup>(4)</sup> (% Motor Current, set by Function 0.01)	<b>25 – 90</b>	60

**Note:** (1) The Output Relay contacts will change state due to all Faults and Recovered Faults. (2) The relay will activate above the setting in Function 5.01 and deactivate below the setting in Function 5.01 minus the setting in Function 5.02. (3) The relay will activate below the setting in Function 5.01 and deactivate above the setting in function 5.01 plus the setting in Function 5.02. (4) The Load Loss Threshold function is not functional during acceleration/deceleration or Stop Mode.

## FUNCTION GROUP 6 – DRIVE STATUS AND RESET

Function No.	Description	Range/Code	Factory Setting
6.00 *	Software Version	—	—
6.01 *	Drive Horsepower	—	—
6.02 *	Fault Log 1	—	—
6.03 *	Fault Log 2	—	—
6.04 *	Fault Log 3	—	—
6.05 **	Reset Drive to Factory Setting	<b>1110:</b> 50 Hz Operation <b>1111:</b> 60 Hz Operation	0000

\*Read only.

\*\*Functions which can only be changed while the drive is in the Stop Mode.

## FUNCTION GROUP 7 – MULTI-FUNCTION INPUT TERMINALS (IODA OPTION BOARD REQUIRED)

Function No.	Description	Range/Code	Factory Setting
7.00 *	Multi-Function Input Terminal 1 <sup>(1)</sup>	<b>0000:</b> Preset Frequency Operation <sup>(2)</sup> <b>0001:</b> Preset Frequency Operation <sup>(2)</sup>	0000
7.01 *	Multi-Function Input Terminal 2 <sup>(1)</sup>	<b>0002:</b> Preset Frequency Operation <sup>(2)</sup> <b>0003:</b> Up Frequency Command (See Function 7.14) <b>0004:</b> Down Frequency Command (See Function 7.14)	0000
7.02 *	Multi-Function Input Terminal 3 <sup>(1)</sup>	<b>0005:</b> Accel/Decel 2 (See Function 7.16) <b>0006:</b> Forward/Stop Command	0000
7.03 *	Multi-Function Input Terminal 4 <sup>(1)</sup>	<b>0007:</b> Reverse/Stop Command <b>0008:</b> External Fault	0000
7.04 *	Multi-Function Input Terminal 5 <sup>(1)</sup>	<b>0009:</b> Reset <b>0010:</b> N.O. Start (2-Wire or 3-Wire Start/Stop) <b>0011:</b> N.C. Stop (3-Wire Start/Stop)	0000
7.05 *	Multi-Function Input Terminal 6 <sup>(1)</sup>		0000
7.06 *	Multi-Function Input Terminal 7 <sup>(1)</sup>		0000
7.07	Preset Frequency 1 (Hz)	<b>0.00 – 240.0</b>	5.00
7.08	Preset Frequency 2 (Hz)	<b>0.00 – 240.0</b>	10.00
7.09	Preset Frequency 3 (Hz)	<b>0.00 – 240.0</b>	20.00
7.10	Preset Frequency 4 (Hz)	<b>0.00 – 240.0</b>	25.00
7.11	Preset Frequency 5 (Hz)	<b>0.00 – 240.0</b>	30.00
7.12	Preset Frequency 6 (Hz)	<b>0.00 – 240.0</b>	35.00
7.13	Preset Frequency 7 (Hz)	<b>0.00 – 240.0</b>	40.00
7.14	Up/Down Frequency Control Mode	<b>0000:</b> Free-Running <sup>(3)</sup> <b>0001:</b> Incremental Change (See Function 7.15)	0000
7.15	Increment of Up/Down Frequency (Hz)	<b>0.01 – 30.00</b>	1.00
7.16	Accel/Decel 2 Time (Seconds)	<b>0.3 – 180.0</b>	1.5

**Note:** (1) Each of the 7 Multi-Function Inputs can be programmed for any of the respective function codes ("0000 – 0011). (2) Preset Frequencies 1 – 7 are obtained by selecting a specific combination of the 3 Multi-Function Input Terminals. The specific frequencies are programmed in Functions 7.07 – 7.13. See Appendix A1, Figure 26 and Table 13, on page 27. (3) The rate of change of the "UP" Control for frequency setting, using external contacts, is proportional to the Accel Time setting (Function 3.03). The incremental rate of change of the "DOWN" Control for frequency setting, using external contacts, is proportional to the Decel Time Setting (Function 3.04).

\*Functions which can only be changed while the drive is in the Stop Mode.

## **Preliminary KBDA Series Drives Installation and Operation Manual**

### **FUNCTION GROUP 8 – MULTI-FUNCTION OUTPUT RELAYS AND OUTPUT SIGNAL OPERATION (IODA OPTION BOARD REQUIRED)**

Function No.	Description	Range/Code	Factory Setting
8.00 *	Multi-Function Output Relay 1 (Terms. 23 – 25)	<b>0000:</b> Run <b>0001:</b> Fault <sup>(1)</sup>	0000
8.01 *	Multi-Function Output Relay 2 (Terms. 26 – 28)	<b>0002:</b> Target Frequency (Function 8.04 ± Function 8.05) <b>0003:</b> Frequency Threshold Level (> Function 8.04 – Function 8.05) <sup>(2)</sup> <b>0004:</b> Frequency Threshold Level (< Function 8.04 + Function 8.05) <sup>(3)</sup>	0001
8.02 *	Multi-Function Open Collector Output 1 (Terms. 11, 12)	<b>0005:</b> I <sup>2</sup> t or I·t Fault <b>0006:</b> Load Loss (See Function 5.03)	0002
8.03 *	Multi-Function Open Collector Output 2 (Terms. 13, 14)	<b>0007:</b> External Fault <b>0008:</b> Motor Overload <sup>(4)</sup>	0004
8.04	Frequency Set Point (Hz)	<b>0.00 – 240.0</b>	0.00
8.05	Frequency Bandwidth (± Hz)	<b>0.00 – 30.00</b>	1.00
8.06	Analog Output 1 Mode (Terms. 15, 16) (0 – 5 VDC)	<b>0000:</b> Motor Frequency <b>0001:</b> Set Frequency <b>0002:</b> Motor Voltage <b>0003:</b> Bus Voltage <b>0004:</b> Motor Current	0000
8.07	Analog Output 1 Gain (%)	<b>0 – 200</b>	100
8.08	Analog Output 2 Mode (Terms. 17, 18) (See 8.09)	<b>0000:</b> Motor Frequency <b>0001:</b> Set Frequency <b>0002:</b> Motor Voltage <b>0003:</b> Bus Voltage <b>0004:</b> Motor Current	0000
8.09	Analog Output 2 Type	<b>0000:</b> 0 – 5 VDC <b>0001:</b> 0 – 20 mA DC <b>0002:</b> 4 – 20 mA DC	0000
8.10	Analog Output 2 Gain (%)	<b>0 – 200</b>	100

**Notes:** (1) The Output Relay contacts will change state due to all Faults and Recovered Faults. (2) The relay will activate above the setting in Function 8.04 and deactivate below the setting in Function 8.04 minus the setting in Function 8.05. (3) The relay will activate below the setting in Function 8.04 and deactivate above the setting in function 8.04 plus the setting in Function 8.05. (4) The Output Relay will change state when the I<sup>2</sup>t or I·t Timer starts.

\*Functions which can only be changed while the drive is in the Stop Mode.

### **FUNCTION GROUP 9 – ANALOG INPUT SIGNAL OPERATION (IODA OPTION BOARD REQUIRED)**

Function No.	Description	Range/Code	Factory Setting
9.00	Analog Input 1 Gain (%)	<b>0 – 500</b>	100
9.01	Analog Input 1 Slope	<b>0000:</b> Positive <b>0001:</b> Negative	0000
9.02	Analog Input 1 Offset	<b>0 – 100</b>	0
9.03	Analog Input 1 Type	<b>0000:</b> Unidirectional <b>0001:</b> Bidirectional	0000
9.04	Analog Input 1 Response Time (mSec)	<b>2 – 100</b>	2
9.05	Analog Input 2 Gain (%)	<b>0 – 500</b>	100
9.06	Analog Input 2 Slope	<b>0000:</b> Positive <b>0001:</b> Negative	0000
9.07	Analog Input 2 Offset	<b>0 – 100</b>	0
9.08	Analog Input 2 Type	<b>0000:</b> Analog Voltage <sup>(1)</sup> <b>0001:</b> PWM <sup>(2)</sup>	0000
9.09	Analog Input 2 Response Time (mSec)	<b>2 – 100</b>	2

**Notes:** (1) Can be used for Current Signal Input, by setting Jumper J1, on the IODA, to the "CUR" position. (2) 0.15 – 1 kHz (0 – 100% duty cycle).

# Preliminary KBDA Series Drives Installation and Operation Manual

## FUNCTION GROUP 10 – COMMUNICATION MODE (DIAC OPTION BOARD REQUIRED)

Function No.	Description	Range/Code	Factory Setting
10.00 *	Assigned Communication Station Number	1 – 247	30
10.01	Communications Watchdog Timer	0000: Disabled 0001: Enabled	0000
10.02	Watchdog Timeout (Seconds)	0.50 – 2.00	0.50
10.03	Operational Command	0 0: Stop 1: Run	—
		1 0: Forward 1: Reverse	
		2 0: N/A 1: Fault Reset	
		3 0: JOG-LCL/REM Command Off 1: JOG-LCL/REM Command On	
		4 0: N/A 1: Preset Frequency 1	
		5 0: N/A 1: Preset Frequency 2	
		6 0: N/A 1: Preset Frequency 3	
		7 0: N/A 1: Preset Frequency 4	
		8 0: N/A 1: Preset Frequency 5	
		9 0: N/A 1: Preset Frequency 6	
		10 0: N/A 1: Preset Frequency 7	
		11 – 15 Reserved	
10.04	Drive Status	0 0: Stop 1: Run	—
		1 0: Forward 1: Reverse	
		2 0: Normal 1: Fault	
		3 0: JOG-LCL/REM Command Off 1: JOG-LCL/REM Command On	
		4 0: N/A 1: Preset Frequency 1	
		5 0: N/A 1: Preset Frequency 2	
		6 0: N/A 1: Preset Frequency 3	
		7 0: N/A 1: Preset Frequency 4	
		8 0: N/A 1: Preset Frequency 5	
		9 0: N/A 1: Preset Frequency 6	
		10 0: N/A 1: Preset Frequency 7	
		11 0: Jog Momentary Mode 1: Jog Latching Mode	
		12 Reserved	
13 0: Local 1: Remote			
		14, 15 Reserved	
10.05	Drive Status Description	00 Normal Operation	—
		01 Short Circuit Trip	
		02 Current Limit	
		03 Current Limit Trip	
		04 Undervoltage Trip	
		05 Recovered Undervoltage Trip	
		06 Overvoltage Trip	
		07 Recovered Overvoltage Trip	
		08 Stop Mode	
		09 Flash Error	
		10 External Fault Trip (IODA)	
		11 IODA Error	
		12 Phase Loss Trip	
10.06 **	Communications Error Count	—	—
10.07 **	Motor Voltage	—	—
10.08 **	Motor Current	—	—
10.09 **	Bus Voltage	—	—
10.10 **	Motor Frequency	—	—

\*Functions which can only be changed while the drive is in the Stop Mode.

\*\*Read only.

## FUNCTION GROUP 11 – RESERVED FUNCTIONS

Function No.	Description	Range/Code	Factory Setting
11.00	Current Limit Multiplier (%)	0 – 200	105
11.01 – 11.09	Reserved	—	—

# Preliminary KBDA Series Drives Installation and Operation Manual

## 11 DIAGNOSTIC LEDs

The drive contains 8 Status LEDs to provide indication of the drive's status and operating mode (Hz, PGM, LCL/REM, STOP, FWD, REV, OL, JOG/REM). See Table 9, for a description of the LEDs.



**WARNING!** Do not depend on the LEDs or the 4-Digit Display to no longer be illuminated as a guaranteed power off condition. Be sure the main power switch or circuit breaker is in the "OFF" position before servicing the drive.

**TABLE 9**  
**LED DESCRIPTIONS**

LED	Description
<b>JOG</b> <input type="checkbox"/> <b>REM</b>	Illuminates when Jog is selected. Flashes when the drive is set for Remote Signal Operation.
<b>OL</b> <input type="checkbox"/>	Illuminates when the drive is in Overload.
<b>FWD</b> <input type="checkbox"/>	Illuminates when the drive is in the Forward Direction.
<b>REV</b> <input type="checkbox"/>	Illuminates when the drive is in the Reverse Direction.
<b>STOP</b> <input type="checkbox"/>	Illuminates when the drive is in the Stop Mode.
<b>Hz</b> <input type="checkbox"/>	Illuminates when the display is set to show Output Frequency.
<b>LCL/REM</b> <input type="checkbox"/>	Illuminates when the JOG-LCL/REM Key is reprogrammed for Local (Keypad) and Remote Signal Operation.
<b>PGM</b> <input type="checkbox"/>	Illuminates when the drive is in the Program Mode.



# Preliminary KBDA Series Drives Installation and Operation Manual

## APPENDIX A – OPTIONAL IODA INPUT/OUTPUT MULTI-FUNCTION BOARD

The IODA Input/Output Multi-Function Board provides a variety of functions which include preset frequency, up/down frequency control, signal isolation, isolated output voltage for controlling auxiliary devices, open collector outputs, and output relay contacts. The IODA mounts on the drive's PC board with 2 snap-ins (located on the bottom of the mounting base) and 2 screws (provided). All of the IODA inputs and outputs are isolated from the AC line.

The IODA has a green power on LED (PWR) and a red status LED (STATUS), which are used to provide operational information of the IODA. See Table 10, below, for a description of the IODA LEDs. See Figure 24, below, for the IODA layout. See Figure 25, on page 26, for the IODA Terminal Block TB1 Layout. See Table 11, on page 26, for the IODA Terminal Block TB1 Wire and Tightening Torque Specifications. See Table 12, on page 26, for the IODA Functions and Features. See Sections A1 – A7, on pages 27 – 29, describing the *Use of the IODA Multi-Function Input Terminals for Remote Operations*. See Sections A8 – A12, on pages 30 – 32, for *Other Functions and Features of the IODA*.

**Local/Remote Operation:** When using the IODA with signal following, it may be appropriate to program the drive for Local/Remote Operation. In this mode, the drive frequency setting can be toggled between a process signal and the keypad using the JOG-LCL/REM Key. Set Function 2.02 (Frequency Control) to "0002" (Analog Signal 1) to change the JOG-LCL/REM Key from Jog Operation to Local/Remote Operation.

**IODA Faults:** External Fault Trip ("EF-t") indicates that a Multi-Function Input Terminal (Functions 7.00 – 7.06 set to "0008") has closed (and will change the state of the Multi-Function Output Relay Contacts (when Function 8.00 or 8.01 is set to "0007")). Current Source Trip ("CS-t") indicates that the current signal output (from the IODA) has been opened. Communication Error ("Err4") indicates that communication between the drive and the IODA has failed.



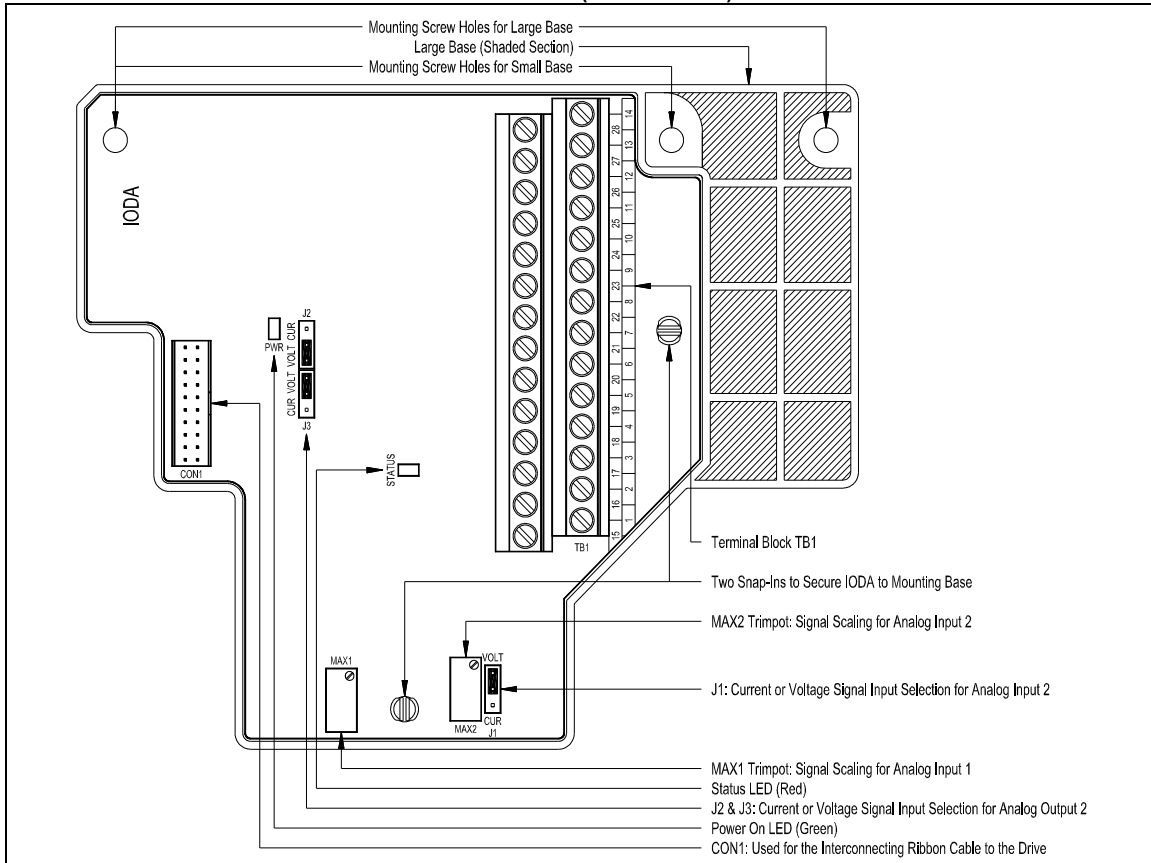
**WARNING!** Do not depend on the LEDs or the 4-Digit Display to no longer be illuminated as a guaranteed power off condition. Be sure the main power switch or circuit breaker is in the "OFF" position before servicing the drive.

**TABLE 10**  
**IODA LED STATUS INDICATORS**

Condition	Red STATUS LED
Normal Operation	Not Illuminated
Communication Error <sup>1</sup>	Flashes 1 Second On and 1 Second Off
Current Source Trip <sup>2</sup>	Illuminated

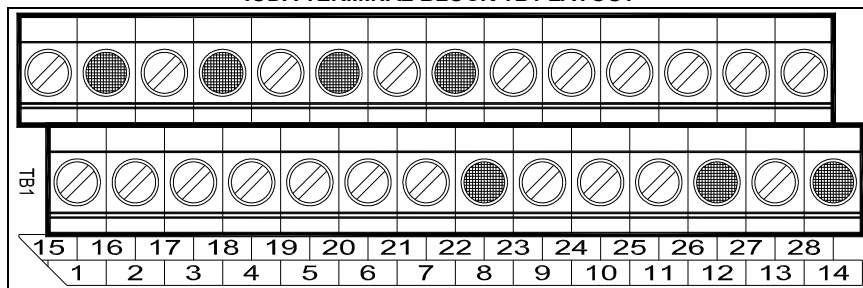
*Notes: 1. When a Communication Error occurs, the drive's 4-Digit Display will show "Err4".  
2. When a Current Source Trip occurs, the drive's 4-Digit Display will show "CS-t".*

**FIGURE 24**  
**IODA LAYOUT (ALL MODELS)\***



\*The IODA kit contains 2 mounting bases. Use the small base for Model KBDA-24D and the large base for Models KBDA-27D, 29, 45, 48.

**FIGURE 25**  
**IODA TERMINAL BLOCK TB1 LAYOUT**



Common Terminals 8, 12, 14, 16, 18, 20, and 22 are all internally connected and are shown shaded.

**TABLE 11**  
**IODA TERMINAL BLOCK TB1**  
**WIRE AND TIGHTENING TORQUE SPECIFICATIONS**

Maximum Wire Size (Cu)		Recommended Tightening Torque	
AWG	mm <sup>2</sup>	in-lbs	kg-cm
16	1.3	6	7

**TABLE 12**  
**IODA FUNCTIONS AND FEATURES**

Multi-Function Input Terminal Codes	Terminal Assignment					
	Multi-Function Input Terminals <sup>1</sup> (Digital Inputs)	Power Supplies <sup>2</sup>	Multi-Function Outputs <sup>2</sup>	Analog Outputs <sup>2</sup>	Analog Inputs <sup>2</sup>	Relay Outputs <sup>3</sup>
<b>0000:</b> Preset Frequency Operation <sup>1</sup> <b>0001:</b> Preset Frequency Operation <sup>1</sup> <b>0002:</b> Preset Frequency Operation <sup>1</sup> <b>0003:</b> Up Frequency Command (See 7.14) <b>0004:</b> Down Frequency Command (See 7.14) <b>0005:</b> Accel/Decel 2 (See 7.16) <b>0006:</b> Forward/Stop Command <b>0007:</b> Reverse/Stop Command <b>0008:</b> External Fault <b>0009:</b> Reset <b>0010:</b> N.O. Stop (2-Wire or 3-Wire Stop/Stop) <b>0011:</b> N.C. Stop (3-Wire Start/Stop)	1 – 7	8: Common 9: +5 Volts 10: -5 Volts	11: Open Collector 1 12: Common 13: Open Collector 2 14: Common	15: Analog Out 1 16: Common 17: Analog Out 2 18: Common	19: Analog In 1 20: Common 21: Analog In 2 22: Common	23: RY1 N.O. 24: RY1 Common 25: RY1 N.C. 26: RY2 N.O. 27: RY2 Common 28: RY2 N.C.

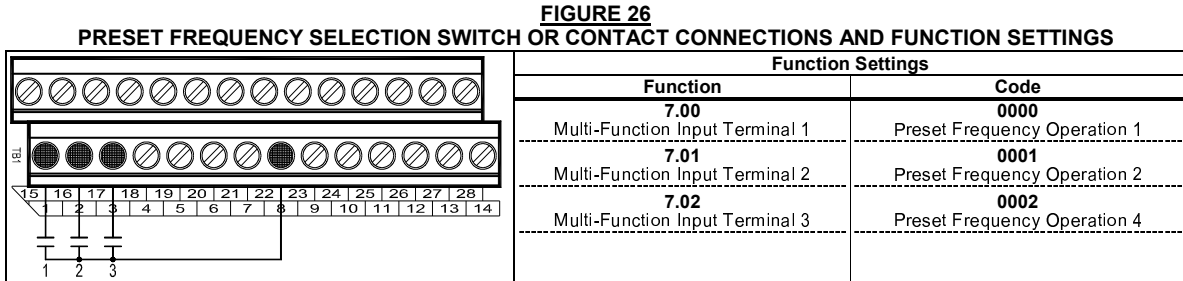
**Notes:** 1. Multi-Function Input Terminals "1" – "7" can be programmed for: 7 Preset Frequencies\*, Up or Down Frequency Command, Accel/Decel 2, Forward/Stop, Reverse/Stop, Coast-to-Stop, Reset, and 3-Wire Start/Stop. 2. Common Terminals 8, 12, 14, 16, 18, 20, and 22 are all internally wired together and can be used with any of the Multi-Function Input Terminals "1" – "7". 3. RY1 Common (Terminal 24) is the contact common only for Relay 1. RY2 Common (Terminal 27) is the contact common only for Relay 2.

\*The 7 Preset Frequencies are obtained using a combination of Terminals 1, 2, 1+2, 3, 1+3, 2+3, 1+2+3.

**USING IODA MULTI-FUNCTION INPUT TERMINALS FOR REMOTE OPERATIONS**

**A1. PRESET FREQUENCIES**

The drive is factory programmed for 7 Preset Frequencies which can be selected using remote switches or contacts connected to the Multi-Function Input Terminals "1" – "7", as shown in Figure 26. See Table 13, for the Multi-Function Input Terminals to select for the preset frequencies. The Preset Frequencies can be changed from their factory settings by reprogramming Functions 7.07 – 7.13 (Preset Frequencies 1 – 7). When the switch or contact is closed, the preset frequency is selected. In Figure 26, Multi-Function Input Terminals "1", "2", and "3" have been arbitrarily chosen. As an example, Functions 7.04, 7.05, and 7.06 can also be programmed to use Multi-Function Input Terminals "5", "6", and "7".



**TABLE 13**  
**PRESET FREQUENCY SELECTION**

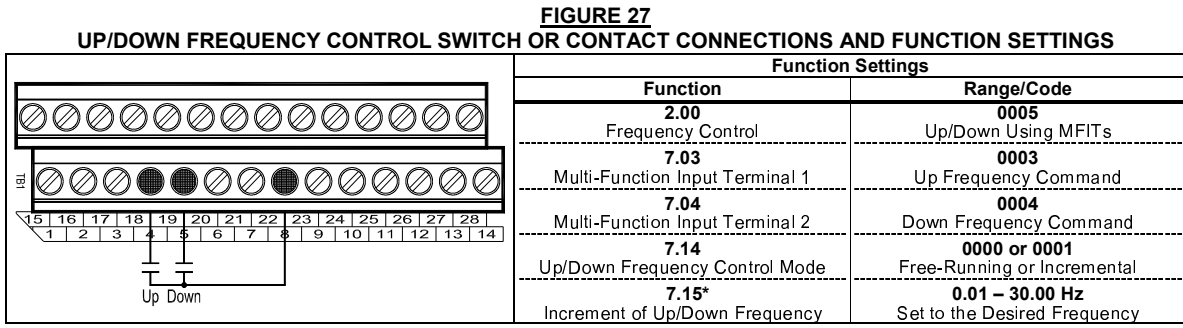
Multi-Function Input Terminals to Select			Preset Frequency		
MFIT 1	MFIT 2	MFIT 3	No.	Hz (Factory Setting)	Function No.
•			1	5.00	7.07
	•		2	10.00	7.08
•	•		3	20.00	7.09
		•	4	25.00	7.10
•		•	5	30.00	7.11
	•	•	6	35.00	7.12
•	•	•	7	40.00	7.13

**A2. UP/DOWN FREQUENCY COMMAND**

The Multi-Function Input Terminals can be used for remote Up/Down Frequency control in lieu of the Keypad or the Built-In Potentiometer. Connect the normally open switches or contacts to any two respective Multi-Function Input Terminal ("1" – "7"). Connect the common of the switches or contacts to Terminal "8" (common). When the "Up" switch or contact is closed, the drive output frequency will increase. When the "Down" switch or contact is closed, the drive output frequency will decrease. See Figure 27.

Set Function 2.00 (Frequency Control) to "0005" (Up/Down Using MFITs). Set the respective Multi-Function Input Terminal (Function 7.00 – 7.06), which will be used for "Up", to "0003". Set the respective Multi-Function Input Terminal (Function 7.00 – 7.06), which will be used for "Down", to "0004". In Figure 27, Multi-Function Input Terminals "4" and "5" have been arbitrarily chosen.

Also see Function 7.14 (Up/Down Frequency control Mode) to set the switch or contact mode for "Free Running" (Function 7.14 set to "0000" (factory setting)) or "Incremental Change" (Function 7.14 set to "0001"). In "Free Running" mode, the rate of change of the "UP" control is proportional to the Accel Time setting (Function 3.03) and the rate of change of the "Down" control is proportional to the Decel Time Setting (Function 3.04). In "Incremental Change" mode, the rate of change of the "UP" or "Down" control is set by Function 7.15 (range is 0.01 – 30.00 Hz (factory set to 1.00 Hz)).



\*Use with Function 7.14 code "0001" only.

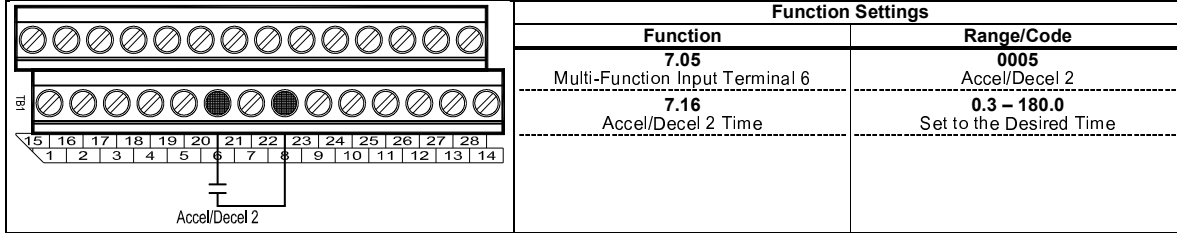
# Preliminary KBDA Series Drives Installation and Operation Manual

### A3. ACCEL/DECEL 2

The drive provides a secondary Accel/Decel Time setting which can be remotely selected with a switch or contact connected to any Multi-Function Input Terminal "1" – "7", as shown in Figure 28.

Set the respective Multi-Function Input Terminal Function 7.00 – 7.06 to "0005" (Accel/Decel 2). The Accel/Decel 2 time is set in Function 7.16 (factory set to 1.5 seconds). When the switch or contact is closed, the Accel/Decel 2 setting is selected (Accel/Decel 2 overrides the Accel and Decel settings in Functions 3.03 and 3.04). In Figure 28, Multi-Function Input Terminal "6" has been arbitrarily chosen.

**FIGURE 28**  
**ACCEL/DECEL 2 SWITCH OR CONTACT CONNECTION AND FUNCTION SETTINGS**

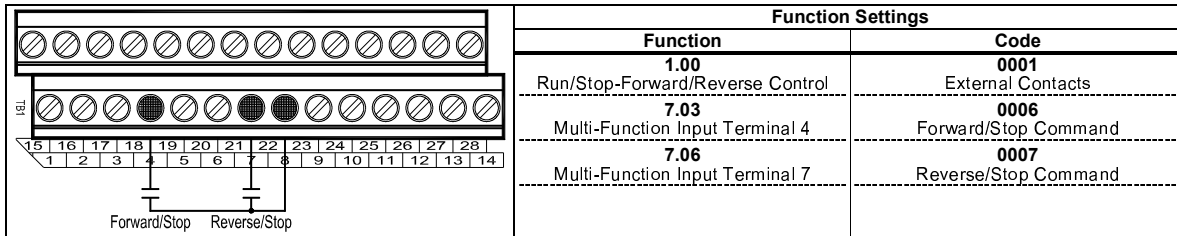


### A4. FORWARD/STOP AND REVERSE/STOP COMMAND

The Multi-Function Input Terminals can be used for remote Forward/Stop and Reverse/Stop operation by connecting a switch or contact to any Multi-Function Input Terminal "1" – "7", as shown in Figure 29. When the "Forward/Stop" switch or contact is closed, the drive will run in the forward direction and when the switch or contact is opened, the drive will stop. When the "Reverse/Stop" switch or contact is closed, the drive will run in the reverse direction and when the switch or contact is opened, the drive will stop.

Set Function 1.00 (Run/Stop-Forward/Reverse Control) to "0001" (External Contacts). Set the respective Multi-Function Input Terminal Function 7.00 – 7.06 which will be used for "Forward/Stop" to "0006". Set the respective Multi-Function Input Terminal Function 7.00 – 7.06 which will be used for "Reverse/Stop" to "0007". In Figure 29, Multi-Function Input Terminals "4" and "7" have been arbitrarily chosen.

**FIGURE 29**  
**FORWARD/STOP-REVERSE/STOP SWITCH OR CONTACT CONNECTIONS AND FUNCTION SETTINGS**

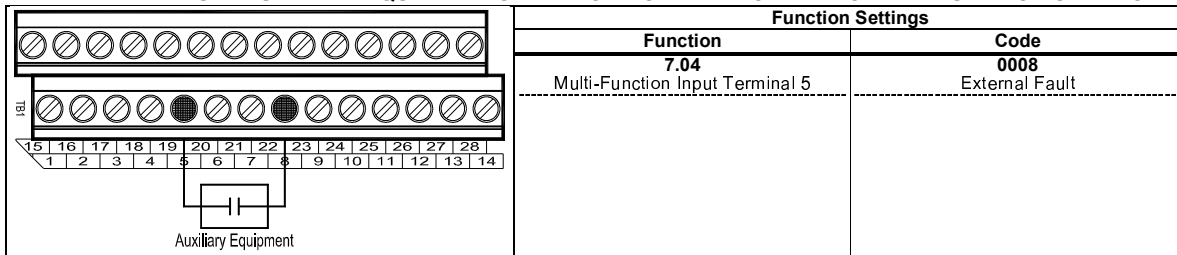


### A5. EXTERNAL FAULT

The Multi-Function Input Terminals can be used to provide feedback to the drive when a fault condition occurs in auxiliary equipment. The connection to the Multi-Function Input Terminals is typically from a normally open relay, contact, or PLC, as shown in Figure 30. When the circuit is closed, the drive will "stop" and the display of the drive will show "EF-t".

Set the respective Multi-Function Input Terminal Function 7.00 – 7.06 which will be used for "External Fault" to "0008". In Figure 30, Multi-Function Input Terminal "5" has been arbitrarily chosen.

**FIGURE 30**  
**EXTERNAL FAULT AUXILIARY EQUIPMENT SWITCH OR CONTACT CONNECTION AND FUNCTION SETTING**

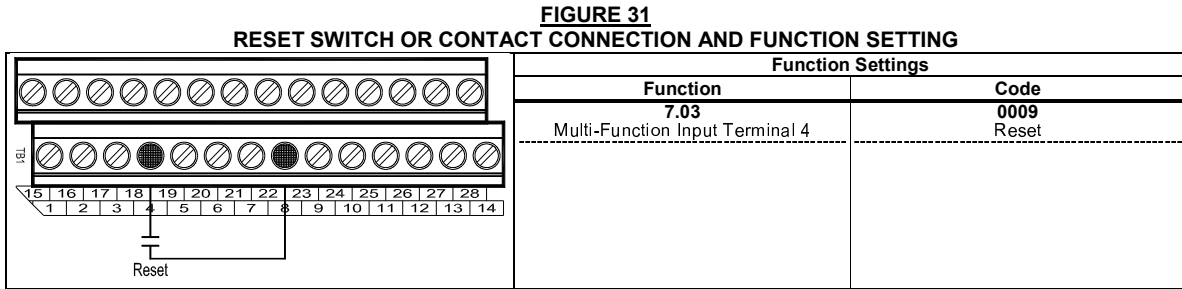


# Preliminary KBDA Series Drives Installation and Operation Manual

## A6. RESET

The Multi-Function Input Terminals can be used to reset the drive, after a fault has been cleared, by connecting a switch or contact to any Multi-Function Input Terminal "1" – "7", as shown in Figure 31.

Set the respective Multi-Function Input Terminal (Function 7.00 – 7.06) to "0006" (Reset). In Figure 31, Multi-Function Input Terminal "4" has been arbitrarily chosen.



## A7. 2-WIRE AND 3-WIRE START/STOP

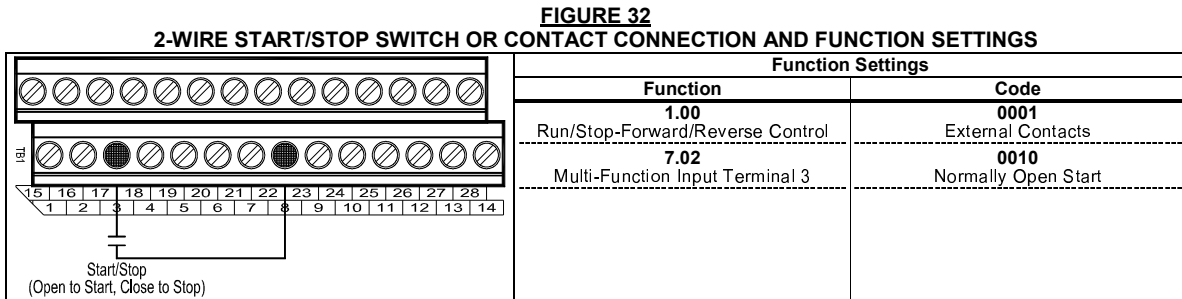
A remote Start/Stop Switch or Contact can be used to start and stop the motor in lieu of the RUN/STOP Key on the Keypad. The Start/Stop Switch or Contact can be connected for 2-Wire or 3-Wire configuration, as described below.

### 2-WIRE START/STOP SWITCH OR CONTACT CONNECTION

**2-Wire Start/Stop requires a maintained switch or contact.** Connect the switch or contact to the respective Multi-Function Input Terminal ("1" – "7") and to Terminal "8" (common), as shown on Figure 32.

Set Function 1.00 (Run/Stop-Forward/Reverse Control) to "0001" (External Contacts). Set the respective Multi-Function Input Terminal (Function 7.00 – 7.06) to "0010" (Normally Open Start). In Figure 32, Multi-Function Input Terminal "3" has been arbitrarily chosen.

*Note: Function code "0011" should not be programmed when using 2-Wire Start/Stop.*

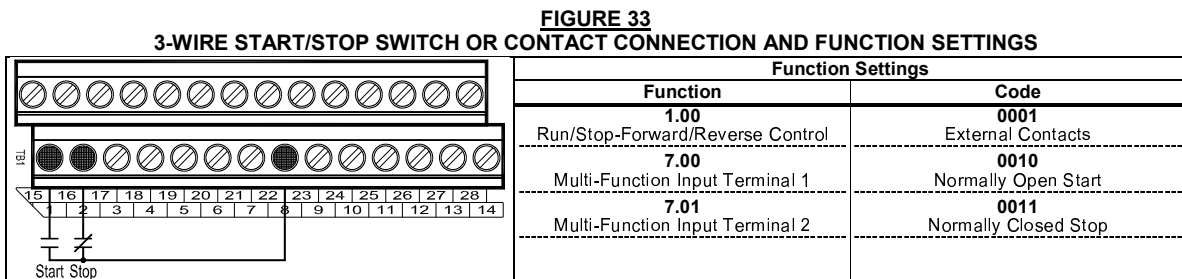


### 3-WIRE START/STOP SWITCH OR CONTACT CONNECTION

**3-Wire Start/Stop requires momentary switches or contacts.** Connect the normally open side of the switch or contact to the respective Multi-Function Input Terminal ("1" – "7"). Connect the normally closed side of the switch or contact to the other respective Multi-Function Input Terminal ("1" – "7"). Connect the common of the switch or contacts to Terminal "8". See Figure 33.

Set Function 1.00 (Run/Stop Mode) to "0001" (External Contacts). Set the respective Multi-Function Input Terminal (Function 7.00 – 7.06), which will be used for the normally open switch or contact, to "0010" (Normally Open Start). Set the respective Multi-Function Input Terminal (Function 7.00 – 7.06), which will be used for the normally closed contact, to "0011" (Normally Closed Stop). In Figure 33, Multi-Function Input Terminals "1" (Function 7.00) and "2" (Function 7.01) have been arbitrarily chosen.

*Note: When using 3-Wire Start/Stop, "Stop" will override "Start", even if the Start Switch or Contact is kept in the "Start" position.*



**OTHER FUNCTIONS AND FEATURES OF THE IODA**

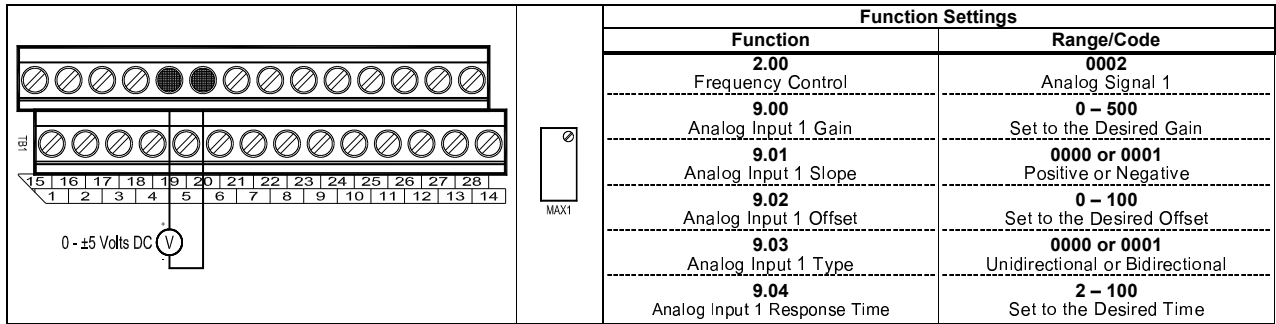
**A8. SIGNAL FOLLOWING**

An analog voltage (unidirectional or bidirectional), current, or PWM signal input can be used to control motor speed in lieu of the Keypad or the Built-in Potentiometer. The drive output will linearly follow the signal input. The inputs can be programmed for the desired gain, slope, offset, and response time. See Function Group 9 (Analog Input Signal Operation).

**Analog Input 1:** Connect the signal input to Terminal "19" and the common to Terminal "20", as shown in Figure 34. See Functions 9.00 – 9.04 (settings for Analog Input 1). Set Function 2.00 (Frequency Control) to "0002" (Analog Input 1). For unidirectional voltage input, set Function 9.03 (Analog Input 1 Type) to "0000" (Unidirectional (factory setting)). For bidirectional voltage input, set Function 9.03 to "0001" (Bidirectional). See Table 14 for Analog Input 1 electrical ratings.

If the Analog Input 1 signal is higher than 5 Volts, use Trimpot MAX1 to attenuate it. Apply the maximum signal input and set the drive for full speed output and observe the display. Rotate Trimpot MAX1 counterclockwise until the drive output frequency begins to drop. Then rotate Trimpot MAX1 clockwise until the display returns to the maximum output frequency.

**FIGURE 34**  
**ANALOG INPUT 1 SIGNAL VOLTAGE FOLLOWING CONNECTION AND FUNCTION SETTINGS**



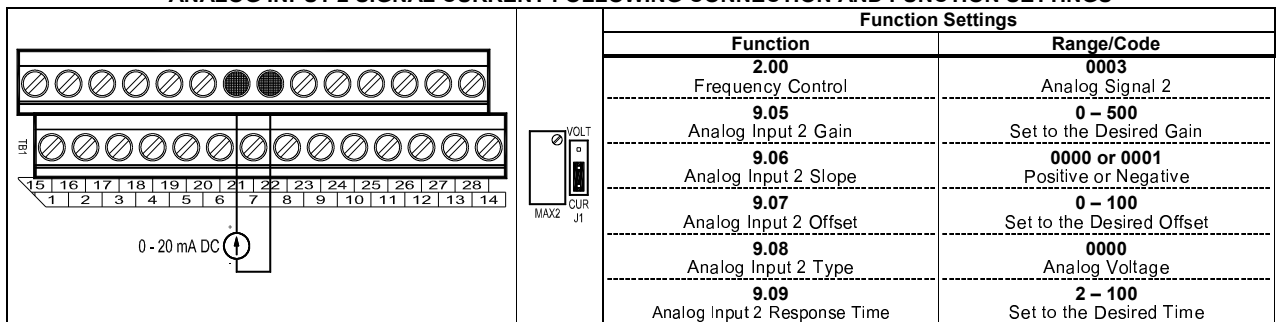
**TABLE 14**  
**ANALOG INPUT 1 ELECTRICAL RATINGS**

Parameter	Specification	Factory setting
Voltage Range (Volts DC)	0 – ±5	0 – 5
MAX1 Scaling Trimpot Range (Volts DC)	0 – 24	5

**Analog Input 2:** Connect the signal input to Terminal "21" and the common to Terminal "22", as shown in Figure 35. See Functions 9.05 – 9.09 (settings for Analog Input 2). Set Function 2.00 (Frequency Control) to "0003" (Analog Input 2). For voltage input, set Jumper J1 to the "VOLT" position and set Function 9.08 (Analog Input 2 Type) to "0000". For current input, set Jumper J1 to the "CUR" position and set Function 9.08 to "0000" (Analog Voltage (factory setting)). For PWM input set Jumper J1 to the "VOLT" position and set Function 9.08 to "0001" (PWM). See Table 15 for Analog Input 2 electrical ratings.

If the Analog Input 2 signal is higher than the input signals specified in Table 15, use Trimpot MAX2 to attenuate it. Apply the maximum signal input and set the drive for full speed output and observe the display. Rotate Trimpot MAX2 counterclockwise until the drive output frequency begins to drop. Then rotate Trimpot MAX2 clockwise until the display returns to the maximum output frequency.

**FIGURE 35**  
**ANALOG INPUT 2 SIGNAL CURRENT FOLLOWING CONNECTION AND FUNCTION SETTINGS**



**TABLE 15**  
**ANALOG INPUT 2 ELECTRICAL RATINGS**

Parameter	Specification	Factory setting
Voltage Range (Volts DC)	0 – 5	0 – 5
MAX2 Scaling Trimpot Range (Volts DC)	0 – 24	5
Current Range (mA DC)	0 – 20*	–
Input Impedance for Current Mode (Ω)	270	–
PWM (kHz, Duty Cycle)	0.15 – 1, 0 – 100	–

\*If using 4 – 20 mA DC signal input, the offset setting in Function 9.07 must be increased from "0%" (factory setting) to "20%". Set Jumper J1 to the "CUR" position.

# Preliminary KBDA Series Drives Installation and Operation Manual

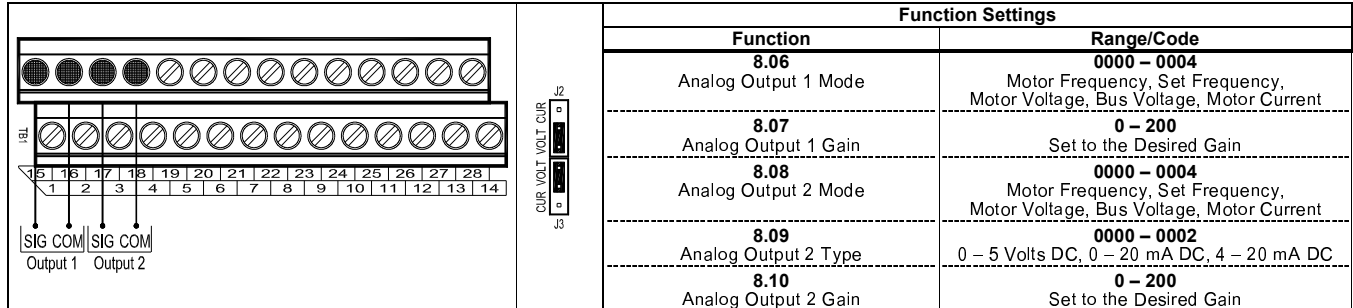
## A9. ANALOG SIGNAL OUTPUT

Two analog signal outputs are provided, which will linearly follow the parameter programmed in Functions 8.06 (Analog output 1 Mode) and 8.08 (Analog Output 2 Mode). They can be used to monitor Motor Frequency, Set Frequency, Motor Voltage, Bus Voltage, and Motor Current. See Table 15 for the Analog Outputs 1 and 2 Electrical Ratings.

**Analog Output 1:** Connect the auxiliary device signal input to Terminal "15" and the common to Terminal "16", as shown in Figure 36. Set Function 8.06 (Analog Output 1 Mode) for the desired parameter to be monitored (factory set to "0000" (Motor Frequency)). Set Function 8.07 (Analog Output 1 Gain) for the desired signal gain (factory set to 100%). Analog Output 1 provides a 0 – 5 Volt DC signal output.

**Analog Output 2:** Connect the auxiliary device signal input to Terminal "17" and the common to Terminal "18", as shown in Figure 36. Set Function 8.08 (Analog Output 2 Mode) for the desired parameter to be monitored (factory set to "0000" (Motor Frequency)). Set Function 8.09 (Analog Output 2 Type) to "0000" (factory setting) for 0 – 5 Volt DC output. Set Function 8.09 (Analog Output 2 Type) to "0001" for 0 – 20 mA DC output. Set Function 8.09 (Analog Output 2 Type) to "0002" for 4 – 20 mA DC output. Set Function 8.10 (Analog Output 2 Gain) for the desired signal gain (factory set to 100%).

**FIGURE 36**  
**ANALOG OUTPUTS 1 AND 2 CONNECTIONS AND FUNCTION SETTINGS**



**TABLE 16**  
**ANALOG OUTPUTS 1 AND 2 ELECTRICAL RATINGS**

Parameter	Specification	Factory setting
Analog Outputs 1 and 2 Voltage Range (Volts DC)	0 – 5	0 – 5
Analog Output 2 Current Range (mA DC)	0 – 20, 4 – 20	–
Analog Output 2 Impedance for Current Mode (Ω)	150	–

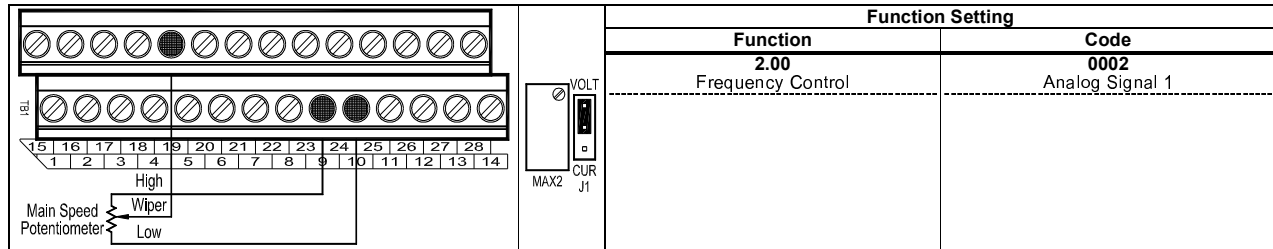
## A10. REMOTE MAIN SPEED POTENTIOMETER

A remote Main Speed Potentiometer (5 kΩ) can be used in lieu of the Keypad or the Built-In Potentiometer. The Main Speed Potentiometer can be connected for forward, reverse, or bidirectional motor speed control, as described below.

### BIDIRECTIONAL MOTOR OPERATION (Use Analog Input 1 Only)

Connect the potentiometer to Terminals "9" (+5 Volts), "19" (Analog Input 1), and "10" (-5 Volts), as shown in Figure 27. Set Function 2.00 (Frequency Control) to "0002" (Analog Input 1). In this mode, the remote potentiometer is set for zero speed at 50% rotation. Rotating the potentiometer clockwise will increase motor frequency in the forward direction. Rotating the potentiometer counterclockwise will increase motor frequency in the reverse direction.

**FIGURE 37**  
**BIDIRECTIONAL MOTOR OPERATION MAIN SPEED POTENTIOMETER CONNECTIONS AND FUNCTION SETTING**



### FORWARD MOTOR OPERATION

**Analog Input 1:** Connect the potentiometer to Terminals "9" (+5 Volts), "19" (Analog Input 1), and "20" (Common). Set Function 2.00 (Frequency Control) to "0002" (Analog Input 1).

**Analog Input 2:** Connect the potentiometer to Terminals "9" (+5 Volts), "21" (Analog Input 2), and "22" (Common). Set Function 2.00 (Frequency Control) to "0003" (Analog Input 2).

### REVERSE MOTOR OPERATION

**Analog Input 1:** Connect the potentiometer to Terminals "10" (-5 Volts), "19" (Analog Input 1), and "20" (Common). Set Function 2.00 (Frequency Control) to "0002" (Analog Input 1).

**Analog Input 2:** Connect the potentiometer to Terminals "10" (-5 Volts), "21" (Analog Input 2), and "22" (Common). Set Function 2.00 (Frequency Control) to "0003" (Analog Input 2).

# Preliminary KBDA Series Drives Installation and Operation Manual

## A11. MULTI-FUNCTION OUTPUT RELAYS

Two Multi-Function Output Relays are provided, which can be programmed for Run, Fault, Target Frequency, Frequency Threshold Level (> 8.04 – 8.05), Frequency Threshold Level (< 8.04 + 8.05), I<sup>2</sup>t or I•t Fault, Load Loss, External Fault, and Motor Overload. Relay 1 is factory programmed to operate as a "Run" Relay (Function 8.00 set to "0000" (factory setting)). Relay 2 is factory programmed to operate as a "Fault" Relay (Function 8.01 (Multi-Function Output Relay 2) set to "0001" (factory setting)). The maximum allowable contact load current is 2 Amps. See Figure 38.

**Note:** If the drive "stops", due to an External Fault Trip ("EF-t"), which indicates that a Multi-Function Input Terminal (Functions 7.00 – 7.06 set to "0008") has closed, the Multi-Function Output Relay Contacts will change state (when Function 8.00 or 8.01 is set to "0007").

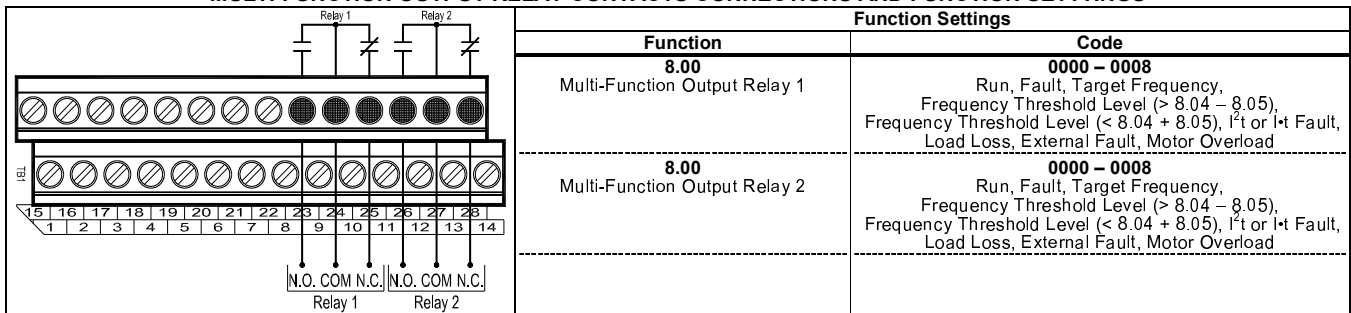
### MULTI-FUNCTION OUTPUT RELAY 1 CONTACTS

**Normally Open (N.O.) Contact:** TB1 Terminal "23".  
**Common (COM):** TB1 Terminal "24" (contact common for Relay 1 only).  
**Normally Closed (N.C.) Contact:** TB1 Terminal "25".

### MULTI-FUNCTION OUTPUT RELAY 2 CONTACTS

**Normally Open (N.O.) Contact:** TB1 Terminal "26".  
**Common (COM):** TB1 Terminal "27" (contact common for Relay 2 only).  
**Normally Closed (N.C.) Contact:** TB1 Terminal "28".

**FIGURE 38**  
**MULTI-FUNCTION OUTPUT RELAY CONTACTS CONNECTIONS AND FUNCTION SETTINGS**



## A12. MULTI-FUNCTION OPEN COLLECTOR OUTPUTS

Two Open Collector Outputs are provided, which can be programmed for Run, Fault, Target Frequency, Frequency Threshold Level (> 8.04 – 8.05), Frequency Threshold Level (< 8.04 + 8.05), I<sup>2</sup>t or I•t Fault, Load Loss, External Fault, and Motor Overload. Open Collector Output 1 is factory programmed to operate as a Target Frequency indicator (Function 8.02 set to "0002" (factory setting)). Open Collector Output 2 is factory programmed to operate as a Frequency Threshold Level (< 8.04 + 8.05) indicator (Function 8.03 set to "0004" (factory setting)). See Figure 39. See Table 17, for the Multi-Function Open Collector Output electrical Ratings.

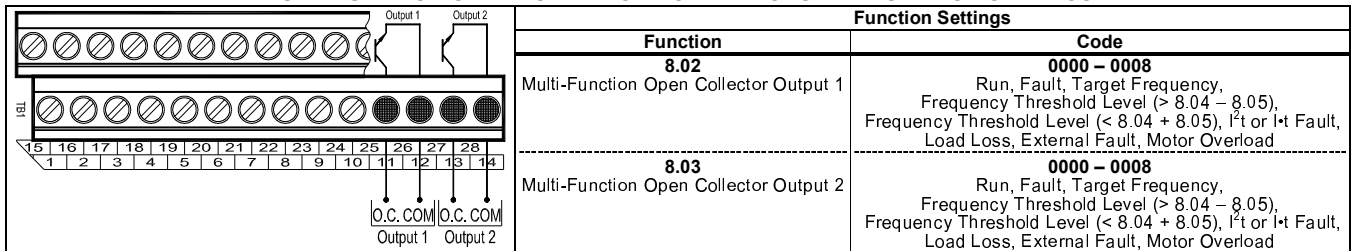
### MULTI-FUNCTION OPEN COLLECTOR OUTPUT 1

**Collector (O.C.):** TB1 Terminal "11".  
**Emitter (COM):** TB1 Terminal "12" (internal circuit common).

### MULTI-FUNCTION OPEN COLLECTOR OUTPUT 2

**Collector (O.C.):** TB1 Terminal "13".  
**Emitter (COM):** TB1 Terminal "14" (internal circuit common).

**FIGURE 39**  
**MULTI-FUNCTION OPEN COLLECTOR CONNECTIONS AND FUNCTION SETTINGS**



**TABLE 17**  
**MULTI-FUNCTION OPEN COLLECTOR OUTPUTS ELECTRICAL RATINGS**

Parameter	Specification	Factory setting
Maximum Voltage (Volts DC)	24	–
Maximum Load Current (mA DC)	60	0 – 20
Minimum External Resistance (Ω)	400	–



**- NOTES -**

**LIMITED WARRANTY**

For a period of 18 months from the date of original purchase, KB Electronics, Inc. will repair or replace without charge, devices which our examination proves to be defective in material or workmanship. This warranty is valid if the unit has not been tampered with by unauthorized persons, misused, abused, or improperly installed and has been used in accordance with the instructions and/or ratings supplied. The foregoing is in lieu of any other warranty or guarantee, expressed or implied. KB Electronics, Inc. is not responsible for any expense, including installation and removal, inconvenience, or consequential damage, including injury to any person, caused by items of our manufacture or sale. Some states do not allow certain exclusions or limitations found in this warranty and therefore they may not apply to you. In any event, the total liability of KB Electronics, Inc. under any circumstance, shall not exceed the full purchase price of this product. (rev 2/2000)

**COPYRIGHT © 2007 KB Electronics, Inc.**

All rights reserved. In accordance with the United States Copyright Act of 1976, no part of this publication may be reproduced in any form or by any means without permission in writing from KB Electronics, Inc. (8/2002)