

Controls

IEC & NEMA Contactors - CWM and CWM-N Series

Mechanical Drawings mm (in)

CWM9, CWM9N, CWM12, CWM18, and CWM18N

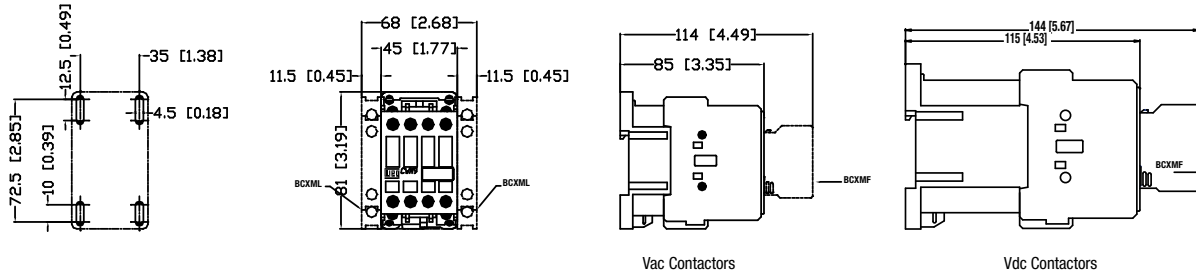

Vac Contactors

Vdc Contactors

CWM25

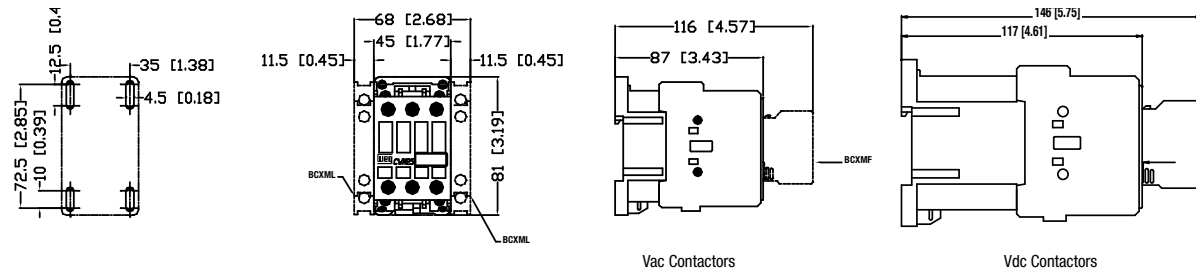

Vac Contactors

Vdc Contactors

CWM32, CWM32N and CWM40

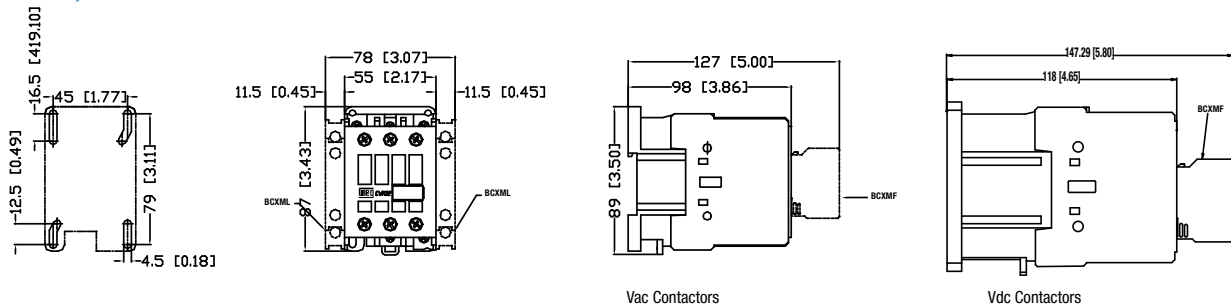

Vac Contactors

Vdc Contactors

Controls

IEC & NEMA Contactors - CWM and CWM-N Series

Mechanical Drawings mm (in)

CWM50, CWM50N, CWM65 and CWM80

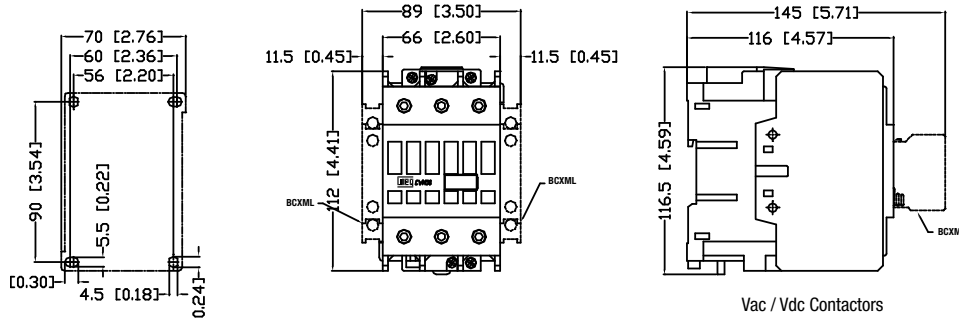

CWM95, CWM95N, and CWM105

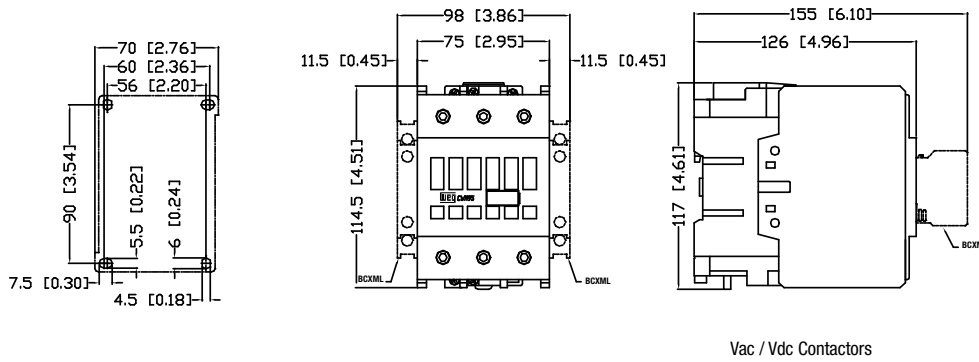

Controls

IEC & NEMA Contactors - CWM and CWM-N Series

Mechanical Drawings mm (in)

CWM112, CWM150 and CWM150N

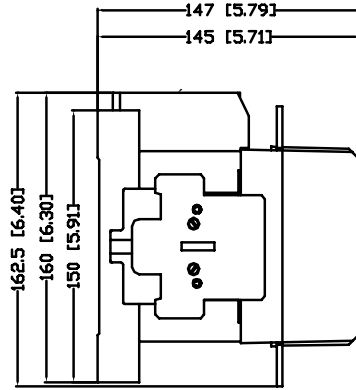
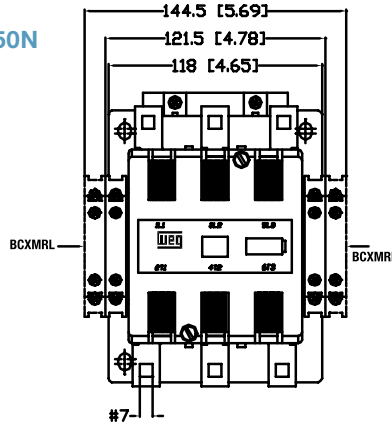
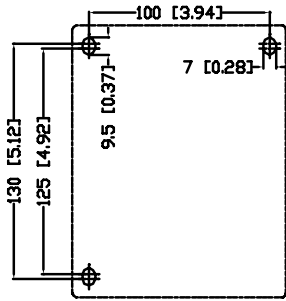

CWM180

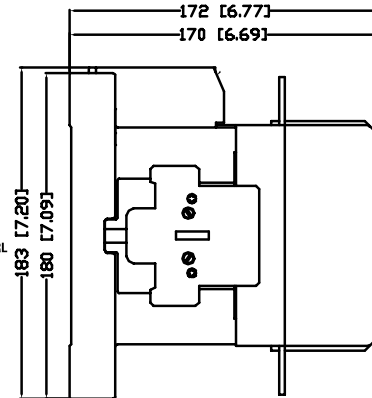
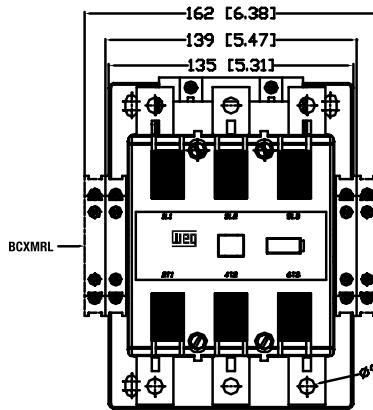
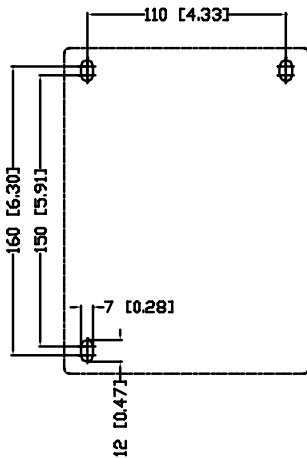

CWM250, CWM300 and CWM300N

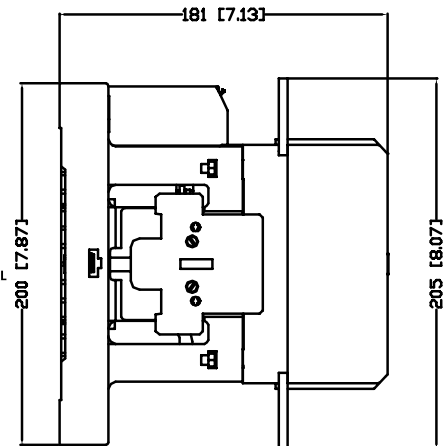
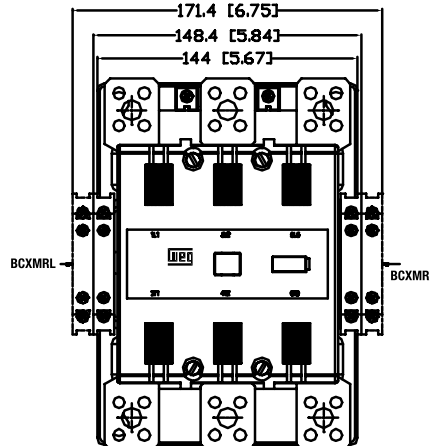
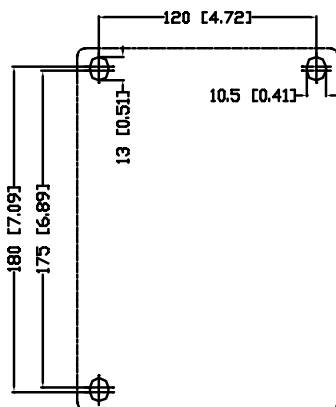



Controls IEC & NEMA Contactors - CWM and CWM-N Series

Mechanical Drawings mm (in)

CWM400

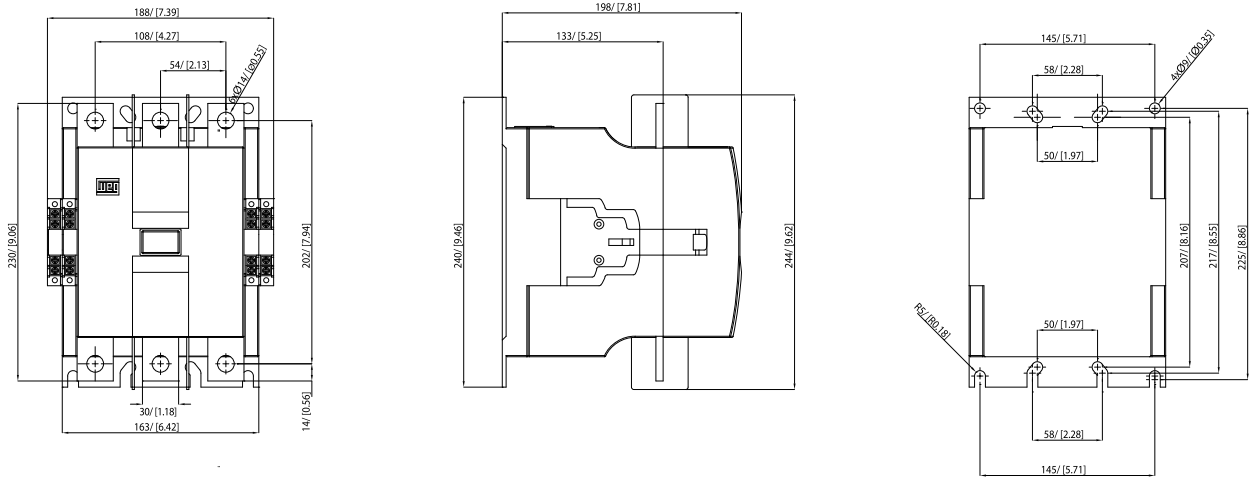

CWM630 and CWM800

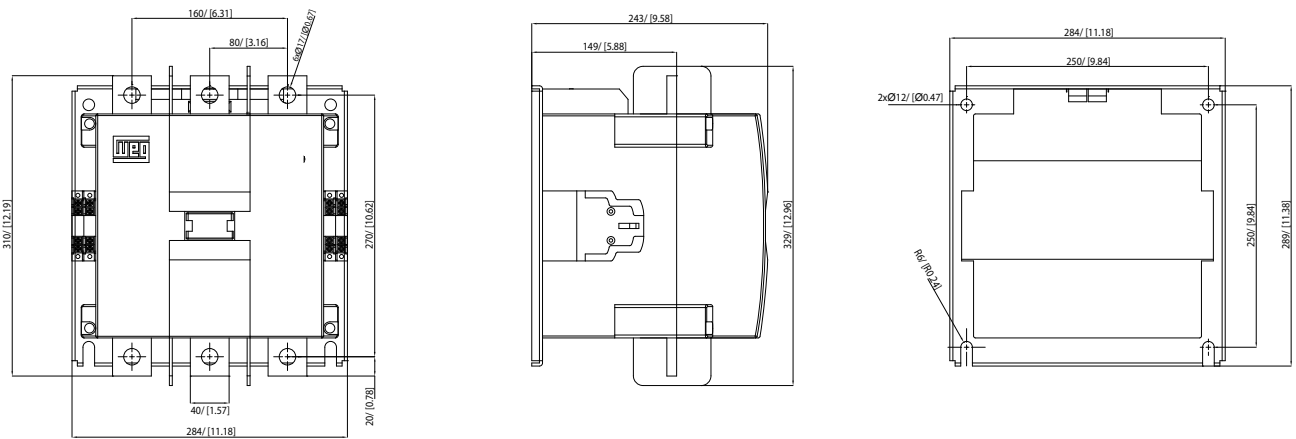

Controls

IEC & NEMA Contactors - CWM and CWM-N Series

Mechanical Drawings mm (in)

CWM112 - CWM150 + LW1-S300 (contactor with lugs)

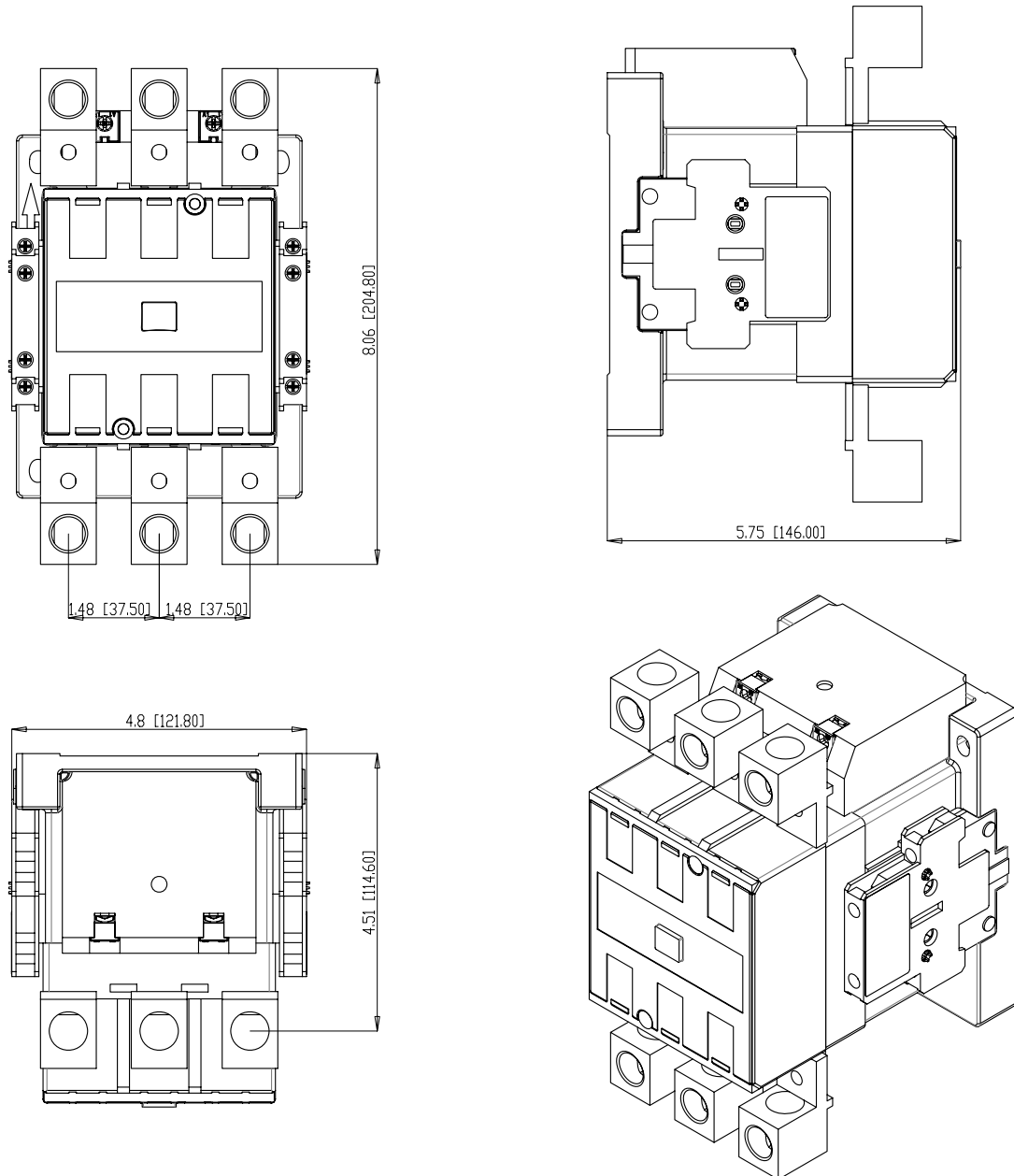

Controls

IEC & NEMA Contactors - CWM and CWM-N Series

Mechanical Drawings mm (in)

CWM180 + LW2-S300 (contactor with lugs)

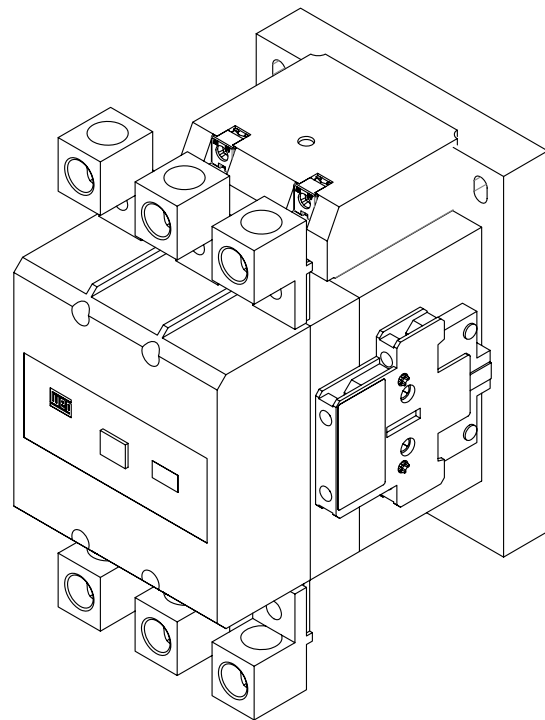
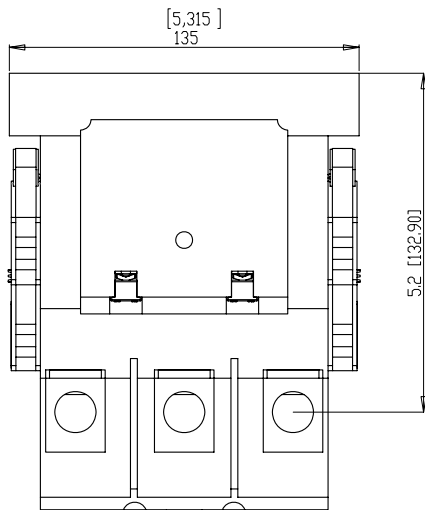
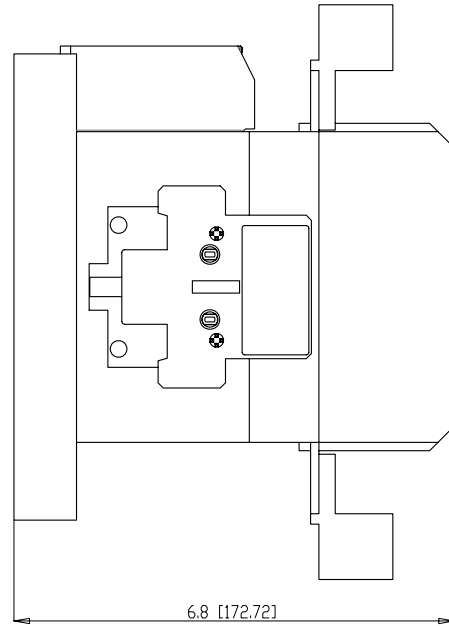
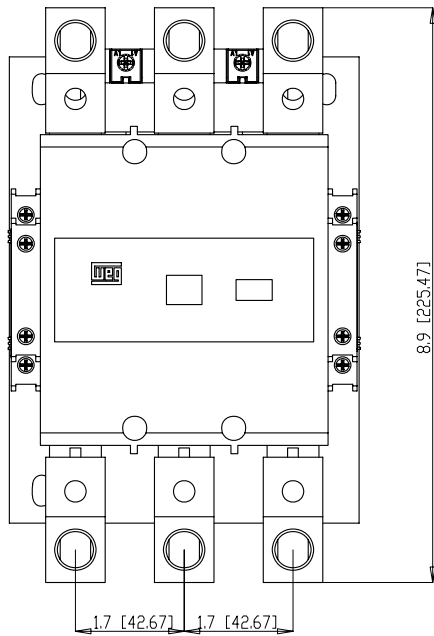

Controls IEC & NEMA Contactors - CWM and CWM-N Series

Mechanical Drawings mm (in)

CWM250 + LW1-S600 (contactor with lugs)

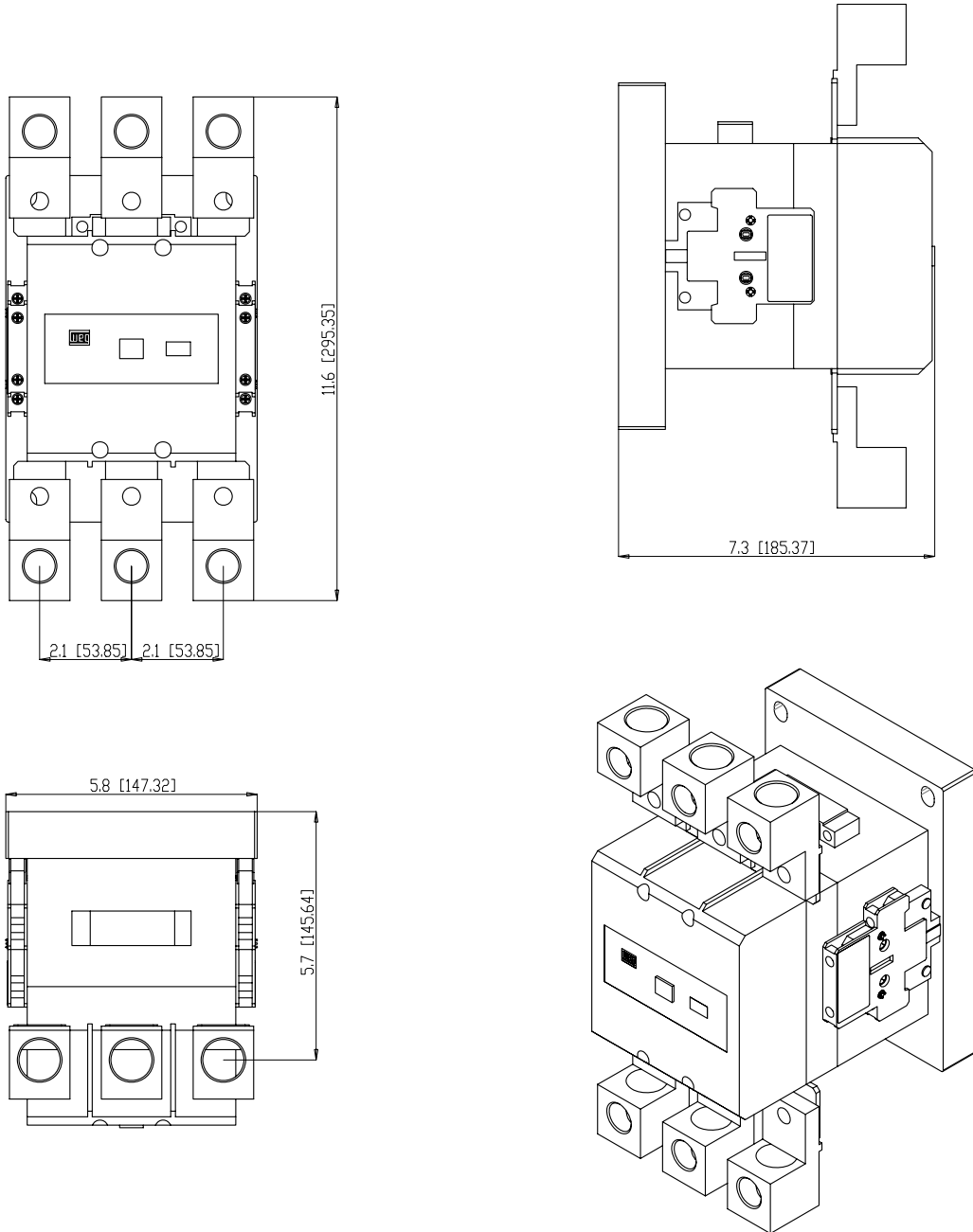

Controls

IEC & NEMA Contactors - CWM and CWM-N Series

Mechanical Drawings mm (in)

CWM400 + BMJ (contactor with lugs)

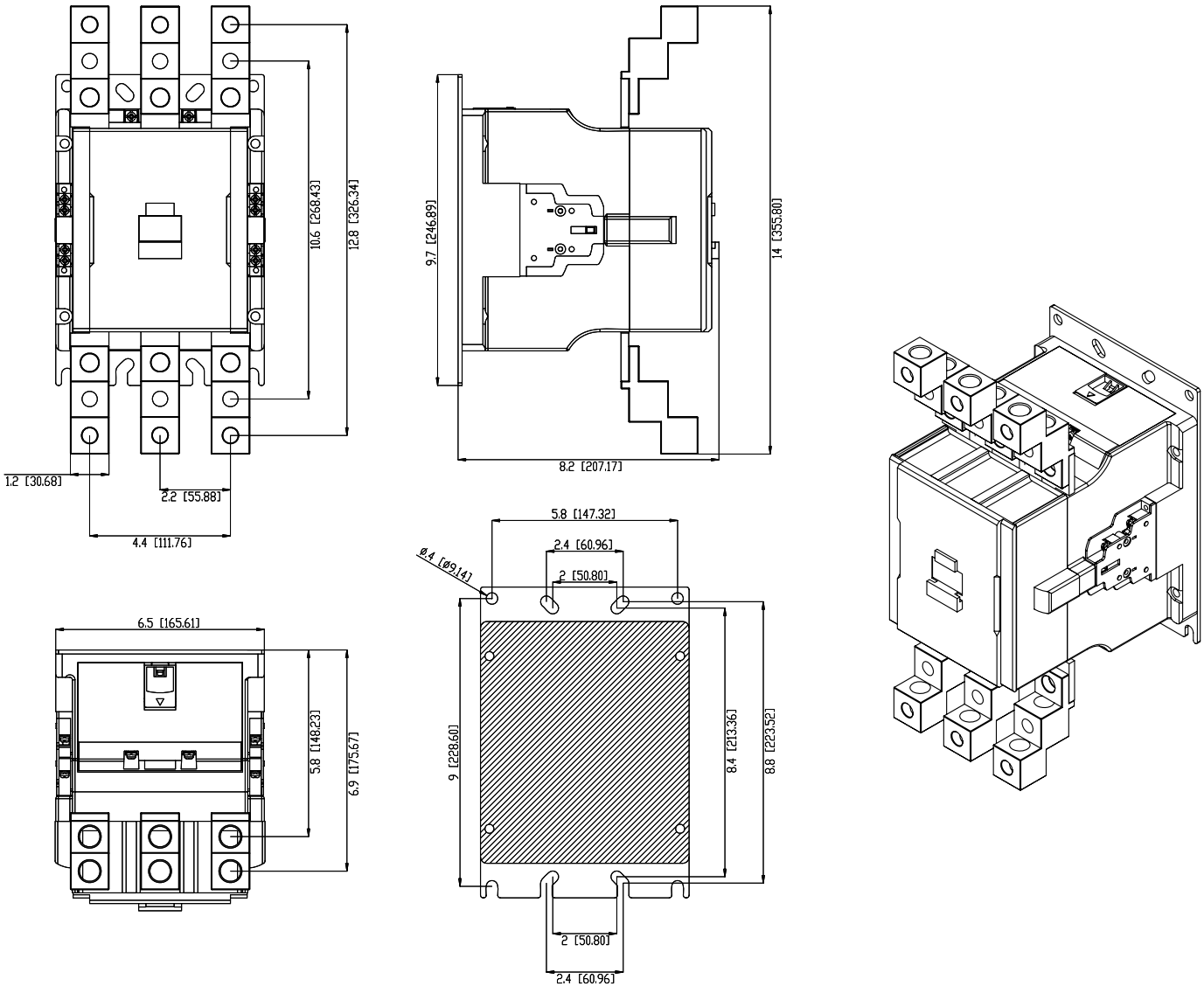

Controls IEC & NEMA Contactors - CWM and CWM-N Series

Mechanical Drawings mm (in)

CWM630-CWM800 + BMJ (contactor with lugs)

